

RADIO'S LIVEST MAGAZINE



Sept.
25 Cents
Canada 30¢

Radio-Craft

*Choke Coil
Design 168 Page*

HUGO GERNSBACK Editor

H.G.T.S.

Build the
**RADIO-CRAFT
UNIVERSAL
ANALYZER**

See Page 138



**Still More New Tubes! — A Twin "Triple-Twin" P. A. Amplifier
How To Make a High-Gain T. R. F. Set — A. V. C. Control Systems**

SPEED

SPEED

SPEED



EFFICIENCY!!

*Ever the Goal of the Progressive
Manufacturer*

EFFICIENCY!!

*Ever the Need of the
Service Man*

EFFICIENCY!!

*Ever Necessary to
Flawless Reception
in the Home.*

SPEED

**Gives this and more....With
Radio's Premier Tube Developments**

**TRIPLE-TWIN • TELEVISION • FOTO-LECTRIC
TUBES**

*Write for latest free bulletins—Turn to Page 192A
for our Card—Keep up with progress by contact with*

SPEED!

CABLE RADIO TUBE CORP.
230-240 NO. NINTH ST. BROOKLYN, N.Y.

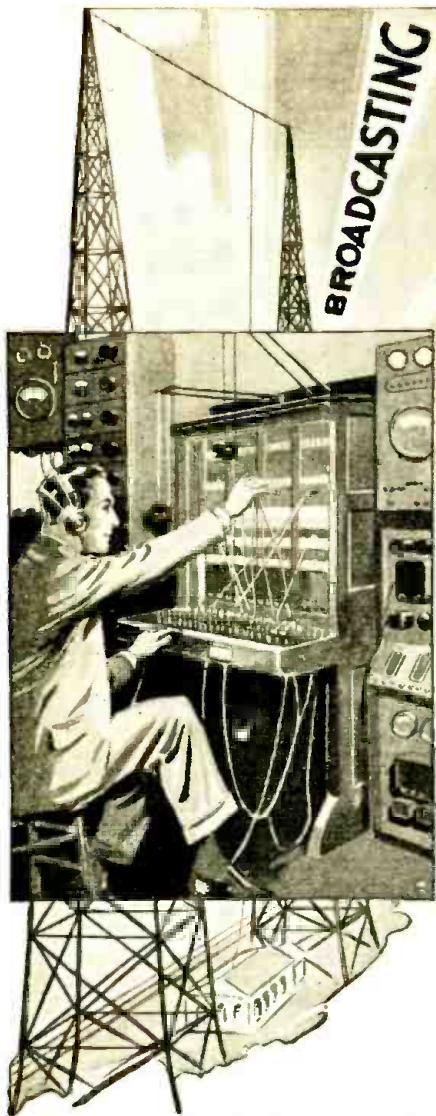

BROADCASTING

TELEVISION

TALKING PICTURES

WIRELESS OPERATING

WIN FAME and FORTUNE in RADIO!

Don't spend your life slaving away in some dull, hopeless job! Don't be satisfied to work for a mere \$20 or \$30 a week. Let me show you how to make money in Radio—the fastest-growing, biggest field on earth!

JOBS LEADING TO SALARIES OF \$50 A WEEK AND UP!

Jobs as Designer, Inspector and Tester—as Radio Salesman and in Service and Installation Work—as operator or Manager of a Broadcasting Station—as Wireless Operator on a Ship or Airplane, as a Talking Picture or Sound Expert—HUNDREDS of OPPORTUNITIES for fascinating, well-paid Jobs!

10 Weeks of Shop Training At Coyne in Chicago

You are given a thorough training in Radio at Coyne—in 10 short, pleasant weeks by actual work on real Radio, Television and Sound equipment. We don't waste time on useless theory. We give you the practical training you will need.

All Practical Work at Coyne

You are not trained by book study at Coyne. We train you on a great outlay of Radio, Television and Sound equipment—on scores of modern Radio Receivers, huge Broadcasting equipment, the very latest Television apparatus, Talking Picture and Sound Reproduction equipment, Code Practice equipment, etc. You don't need advanced education or previous experience. We give

you—right here in the Coyne Shops—the actual practice and experience you'll need.

TELEVISION

Is Now Here!

And TELEVISION is already here! Soon there'll be a demand for THOUSANDS of TELEVISION EXPERTS! The man who learns Television NOW can have a real future in this great new field. Get in on the ground-floor of this amazing new Radio development! Learn Television at COYNE on the very latest, newest Television equipment.

Talking Pictures A Great Field

Talking Pictures and Public Address Systems offer thousands of golden opportunities to the Trained Radio

man. Here is a great new field of Radio that has just started to grow! Prepare NOW for these marvelous opportunities! Learn Radio Sound Work at Coyne, on actual Talking Picture and Sound Reproduction equipment.

Coyne is 32 Years Old

You get Free Employment Help as long as you live. And if you need part-time work while at school to help pay expenses we'll gladly do all we can to get it for you if you will tell us your problems. Coyne is 32 years old! Coyne training is tested—proven beyond all doubt. You can find out everything ABSOLUTELY FREE. JUST MAIL COUPON FOR MY BIG FREE BOOK, telling all about jobs—salaries—opportunities. Mail the coupon—NOW!

H. C. Lewis, Pres.

Radio Division

Founded 1899

Coyne Electrical School

500 S. Paulina Street Dept. 62-8H Chicago, Illinois

H. C. LEWIS, President

Radio Division, Coyne Electrical School
500 S. Paulina St., Dept. 62-8H Chicago, Ill.

Dear Mr. Lewis:—

Send me your Big Free Radio Book and all details of your Special Offer.

Name.....

Address.....

City.....State.....



HUGO GERNSBACK, Editor-in-Chief

LOUIS MARTIN
Associate Editor

R. D. WASHBURNE
Technical Editor

CONTENTS OF THE SEPTEMBER, 1932, ISSUE

VOLUME IV

Number 3

EDITORIAL:

What is Wrong With Television?..... Hugo Gernsback 137

NEW DEVELOPMENTS IN RADIO:

A New Lapel Microphone..... Dr. Irving J. Saxl 141
Still More New Tubes!..... Louis Martin 142
The Latest Radio Equipment..... 145
An Automotive "B" Eliminator Dr. Joseph H. Kraus 152

SERVICE MEN'S DEPARTMENT:

The Radio-Craft Universal Analyzer
The Engineering Staff of Radio-Craft 138
A New Set Tester..... 153
Improvements in Electrolytic Condensers
Donald E. Gray 154
Operation and Service of Automatic Volume Control
Systems..... W. S. Williams 155
How to Use a Set Analyzer..... F. L. Sprayberry 156
The Service Man's Forum..... 157
Short Cuts in Radio Service..... 158
Operating Notes..... Bertram M. Freed 160

RADIO SERVICE DATA SHEETS:

No. 73: Clarion DeLuxe Models AC-280 and 25-280
12-Tube Superheterodyne..... 162
No. 74: Majestic 9-Tube Screen-Grid Superhetero-
dyne, A.V.C. Model 290 Chassis..... 163
Over-the-Counter Suggestions..... Jack Grand 170

TECHNICAL RADIO TOPICS:

Radio A La Cortlandt Street!..... Robert Hertzberg 146
How to Build A High-Gain T. R. F. Receiver
S. H. Burns 148
A Triple-Twin P. A. Amplifier..... Harry Georges 150
How to Construct 46, Class B Apparatus
C. H. W. Nason 151
Reducing Noise With Short-Wave Collectors
Arthur H. Lynch 164
RADIO-CRAFT Kinks..... 165
The Radio Craftsman's Page..... 166
RADIO-CRAFT's Information Bureau..... 167
Book Review..... 172
Retarding Secondary Emission in Vacuum Tubes
Raymond Szymanowicz 187
A Supersensitive Photoelectric Cell. Dr. Fritz Noack 192A
Drafting Musical Compositions..... Otto Kappelmayer 192B

IN OUR NEXT FEW ISSUES:

LOUDSPEAKER DESIGN DATA. Every technician has his own ideas as to just what "makes the sound come out." However, the author of this two-part article gives in the first one the real facts and in the second, data on new devices.

MODERNIZING THE "HI-Q 29" RECEIVER. About a "million" (more or less) owners of this popular Hammarlund-Roberts set model are prospects for this simple conversion job.

PROFIT VIA THE RADIO SERVICE LABORATORY. Few service organizations make any intensive effort to capitalize on the money-making possibilities of their service equipment and personnel. However, one firm is doing this—profitably!

AN UP-TO-DATE REFLEX RECEIVER. Using the new tubes, this instrument design exploits latent possibilities for extremely high efficiency with a limited number of tubes.

RADIO-CRAFT is published monthly, on the fifth of the month preceding that of date; its subscription price is \$2.50 per year. (In Canada and foreign countries, \$3.00 a year to cover additional postage.) Entered at the post office at Mt. Morris, Ill., as second-class matter under the act of March 3, 1879. Trademark and copyright by permission of Gernsback Publications, Inc., 98 Park Place, N. Y. C.

Text and illustrations of this magazine are copyright and must not be reproduced without permission of the copyright owners. We are also agents for WONDER STORIES and WONDER STORIES QUARTERLY. Subscription to these magazines may be taken in combination with RADIO-CRAFT at reduced Club rates. Write for information.

Copyright 1932. GERNSBACK PUBLICATIONS, INC.

H. GERNSBACK, President
S. GERNSBACK, Treasurer

J. M. HERZBERG, Vice-President
I. S. MANHEIMER, Secretary

Published by **TECHNI-CRAFT PUBLISHING CORPORATION**. Publication office: 404 No. Wesley Ave., Mount Morris, Illinois. Editorial and Advertising Office: 96-98 Park Place, New York City. Chicago Advertising Office: 737 North Michigan Avenue, Chicago, Ill. Western Advertising office: 220 No. Catalina St., Los Angeles, Calif. L. F. McClure, Chicago Advertising Representative. Loyd B. Chappell, Western Advertising Representative.

London Agent: Hachette & Cie., 3 La Belle Sauvage, Ludgate Hill, E.C. 4
Paris Agent: Hachette & Cie., 111 Rue Reaumur
Australian Agent: McGill's Agency
179 Elizabeth St., Melbourne



J. E. Smith, President, National Radio Institute, the man who has directed the Home Study training of more men for the Radio Industry than any other man in America.

BE A RADIO EXPERT

Many Make **\$50 to \$100** a Week

I'll Train You at Home in Your Spare Time for **RADIO · TELEVISION · TALKING MOVIES**



Set Servicing

Spare-time set servicing pays many N.R.I. men \$200 to \$1,000 a year. Full-time men make as much as \$65, \$75, and \$100 a week.

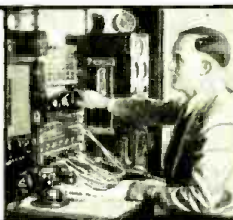

Broadcasting Stations

Employ trained men continually for jobs paying up to \$5,000 a year.



Ship Operating

Radio operators on ships see the world free and get good pay plus expenses. Here's one enjoying shore leave.

Aircraft Radio

Aviation is needing more and more trained Radio men. Operators employed through Civil Service Commission earn \$1,620 to \$2,800 a year.



Talking Movies

An invention made possible by Radio. Employs many well trained Radio men for jobs paying \$75 to \$200 a week.



Television

The coming field of many great opportunities is covered by my course.



If you are dissatisfied with your present job, if you are struggling along in a rut with little or no prospect of anything better than a skinny pay envelope—clip the coupon NOW. Get my FREE book on the opportunity in RADIO. Read how quickly you can learn at home in your spare time to be a Radio Expert—what good jobs my graduates have been getting—real jobs with real futures.

Many Radio Experts Make \$50 to \$100 a week

In about ten years the Radio Industry has grown from \$2,000,000 to hundreds of millions of dollars. Over 300,000 jobs have been created by this growth, and thousands more will be created by its continued development. Many men and young men with the right training—the kind of training I give you in the N.R.I. course—have stepped into Radio at two and three times their former salaries.

Get Ready Now for Jobs Like These

Broadcasting stations use engineers, operators, station managers, and pay up to \$5,000 a year. Manufacturers continually employ testers, inspectors, foremen, engineers, service men, buyers, for jobs paying up to \$6,000 a year. Radio Operators on ships enjoy life, see the world, with board and lodging free, and get good pay besides. Dealers and jobbers employ service men, salesmen, buyers, managers, and pay up to \$100 a week. My book tells you about these and many other kinds of interesting Radio jobs.

Many Make \$5, \$10, \$15 a Week Extra in Spare Time Almost at Once

The day you enroll with me I send you material which you should master quickly for doing 28 jobs common in

most every neighborhood, for spare-time money. Throughout your course I send you information on servicing popular makes of sets! I give you the plans and ideas that have made \$200 to \$1,000 a year for N.R.I. men in their spare time. My course is famous as the course that pays for itself.

Talking Movies, Television, Short Wave Radio I Give You a Money Back Agreement

Special training in Talking Movies, Television, and Home Television experiments. Short Wave Radio, Radio's use in Aviation, Servicing and Merchandising Sets, Broadcasting, Commercial and Ship Stations are included. I am so sure that N.R.I. can train you satisfactorily that I will agree in writing to refund every penny of your tuition if you are not satisfied with my Lesson and Instruction Service upon completion.

64-page Book of Information FREE

Get your copy today. It's free to all residents of the United States and Canada over 15 years old. It tells you where Radio's good jobs are, what they pay, tells you about my course, what others who have taken it are doing and making. Find out what Radio offers you without the slightest obligation. ACT NOW!

J. E. SMITH, President
National Radio Institute
Dept. 2JX
Washington, D. C.



Special FREE Offer

Act now and receive in addition to my big free book, "Rich Rewards in Radio," this Service Manual on D.C., A.C., and Battery operated sets. Only my students could have this book in the past. Now readers of this magazine who mail the coupon will receive it free. Overcoming hum, noises of all kinds, fading signals, broad tuning, howls, and oscillations, poor distance reception, distorted or muffled signals, poor Audio and Radio Frequency amplification and other vital information is contained in it. Get a free copy by mailing the coupon.



THIS COUPON IS GOOD for **One FREE COPY OF MY BOOK**

mail it **now**

J. E. SMITH, President
National Radio Institute, Dept. 2JX
Washington, D. C.

Dear Mr. Smith: I want to take advantage of your Special Offer. Send me your two books, "Trouble Shooting in D.C., A.C. and Battery Sets" and "Rich Rewards in Radio." I understand this request does not obligate me.

Name

Address

City State M

A NEW FREE SERVICE

Booklets that will be mailed to you free if you send in coupon below

60. THE NEW POWERIZER MICROMIKE

Radio and public address engineers have long realized that some means would have to be devised to enable a speaker addressing an audience to move around freely, instead of remaining fixed in one position in front of a stationary microphone. They have met this problem with the design of extremely small "mikes" which fit in the lapel of the speaker's coat. One of the most successful instruments of this type, the new Powerizer "Micromike," is described in an interesting bulletin of the above name. The folder emphasizes the fact that the Micromike is not a toy, but a carefully made, high quality microphone for serious use in radio, public address and home recording work. The item is of interest to radio Service Men and others who handle P.A. systems and associated voice amplifier equipment. *Radio Receptor Company.*

61. THE AEROVOX RESEARCH WORKER

The "Research Worker" is an excellent little house organ of the Aerovox Corporation and is issued every now and then, free of charge, to radio experimenters, engineers and Service Men. If you want to have your name put on the mailing list, merely send in the coupon on this page. The publication runs from four to eight pages, and contains some really useful and practical information, mostly on fixed condensers and resistors of all types. Recent issues, copies of which are available for distribution, contain articles on the following subjects: The theory, operation and construction of the dry electrolytic condenser; A new type of inductance capacity reactance chart (which is well worth saving); Voltage divider circuits; and resistance-capacity filters for plate and grid circuits. The diagrams charts and tables are particularly useful to the Service Man who has neither the time nor the inclination to work out mathematical formulas. *Aerovox Corporation.*

62. RACON REPRODUCERS

The increasing popularity of public address systems is inspiring loud speaker manufacturers to increased activity. More than a dozen distinctly different types of speakers are described and illustrated in the latest Racon catalog, which is both interesting and educational to the public-address technician. One of the outstanding reproducers illustrated in this catalog is a radial horn 43 inches

Radio-Craft

READERS' BUREAU

On this page are listed booklets, catalogs, pamphlets, etc., of Manufacturers, Schools, Institutions, and other organizations, which may be of interest to readers of "Radio-Craft." The list is revised each month, and it will be kept as up-to-date and accurate as possible. In all cases the literature has been selected because of the valuable information which the books contain.

This Service is absolutely free to all Readers of "Radio-Craft."

Fill in and mail the coupon below; make sure that your name and address are included and are plainly written. Order by number only.

wide and 50 inches high, which is designed to project sound over a complete circle of 360 degrees, distributing it with even intensity. It is particularly adapted to use on trucks and towers and in amusement parks or other places where uniform sound projection is necessary. A number of speaker units and accessories are also described. *Racon Electric Company, Inc.*

63. THE AKAFORMER

The Akaformer, described in this folder, is a coupling device that hooks right on to the aerial wire, and connects to the set through a shielded down lead. The combination tends to reduce noise in the

set picked up by the usual lead in, which, running along the side of the building, is more readily affected by elevator motors, vacuum cleaners, dentists' drills and other electrical machinery than the flat top section of the aerial proper. The device is inexpensive and is easily installed, and is thereby a very profitable item for Service Men located in districts where artificial noise is very troublesome. *Amy, Aceves & King, Inc.*

64. SYLVANIA RADIO TUBES

So many new tubes have appeared during the past several months that tube charts printed as recently as the Spring are incomplete and therefore of little value for reference purposes. Readers desiring new and complete charts for their shop wall will find the new Sylvania chart very desirable. It measures 11 by 17 inches when unfolded and shows bottom views of the tube bases in addition to full average characteristics of old tubes dating back to the 199 and 200A and all the new tubes including the latest 6.3 and 2.5 volt types. Special mention is made of the 56, 57, 58, 46, and 82 tubes; complete data are also given on the 38, 41, 69, 42 and 44. *Hygrade Sylvania Corporation.*

65. MECHANICAL REMOTE TUNING CONTROLS FOR RADIO RECEIVERS

The present boom in automobile radio is serving to emphasize the importance of flexible shafts and other means of remote tuning controls, which, in many of the early sets of this type, were decidedly unsatisfactory. This bulletin discusses the problem from the engineering standpoint and describes the well known line of S. S. White flexible shafts, which are intended for airplane, automobile and other types of mobile radio receivers and transmitters for broadcast or commercial purposes. *S. S. White Dental Mfg. Co., Industrial Division.*

66. WHOLESALE RADIO SERVICE CATALOG

The 1932 Spring and Summer Radio Catalog of the Wholesale Radio Service Company is the kind of catalog the radio Service Man and experimenter will carry around with him all the time in his back pocket. Measuring 7 by 10 1/4 inches and containing 100 pages, it is one of the most complete catalogs we have ever seen. It includes everything from soldering lugs to all-wave combinations, and is of particular value to the Service Man because of its handy lists of replacement parts for standard receivers. *Wholesale Radio Service Company, Inc.*

RADIO-CRAFT	60-66
Readers Bureau	
96-98 Park Place, New York, N. Y.	
Please send me free of charge the following booklets indicated by numbers in the published list above:	
No.
Name
Address
City.....	State.....

Announcing a New receiver

POSITIVELY Guaranteed TO RECEIVE
REGULARLY, WITH LOUD SPEAKER
VOLUME, FOREIGN STATIONS ♦ ♦
10,000 MILES OR MORE DISTANT

THE SCOTT ALLWAVE DELUXE

Eleven new and sensational developments enable this receiver to completely shatter all previous known standards of radio performance



No Plug-In Coils or Tapped Coils—New system actually MORE efficient than Plug-In Coils.

Single Dial tunes BOTH R. F. and oscillator circuits from 15 to 550 meters, perfectly and *automatically* WITHOUT TRIMMERS, by newly developed method protected by patents pending.

4/1000ths Microvolt Sensitivity—This truly tremendous power brings in stations 10,000 miles distant with volume of a local station.

New Selectivity Masters Every Channel—Laboratory curves prove DELUXE MODEL most selective receiver ever built. Absolute 10 KC separation at 200 times signal ratio.

New Class "A" Linear Amplifier—Gives perfectly uniform response to all frequencies from 30 to 8,000 cycles—Provides perfect reproduction and linear output at LOW as well as HIGH volume.

New Twin Speakers—Laboratory-matched to give richness and thrilling realism and to eliminate all trace of speaker distortion or blasting at high volume.

New Tonal Realism—The perfectly engineered combination of CLASS "A" Amplifier, laboratory-matched twin speakers—and receiver—gives to the tone of the SCOTT ALLWAVE DELUXE the fourth dimension lacking in all ordinary reproduction.

New Type Tubes Used in highly developed circuits secure amplification never before attained in a radio receiver.

Static Suppressor reduces atmospheric noises to minimum, permitting practical use of our extreme sensitivity on far distant stations.

100% Shielding—Makes possible full use of tremendous sensitivity without slightest trace of oscillation.

New Scott Slow Motion Drum Dial—No cords or cables to get out of adjustment—Positive drive without back lash.

Guaranteed Daily World Wide Reception in your own home—any day of the month—any month of the year.



Send for Technical Details, Laboratory Information and Proof of the above statements. Use the coupon. Mail it today to

THE E. H. SCOTT RADIO LABORATORIES, INC.
4450 Ravenswood Ave., Dept. C-92 Chicago, Ill.

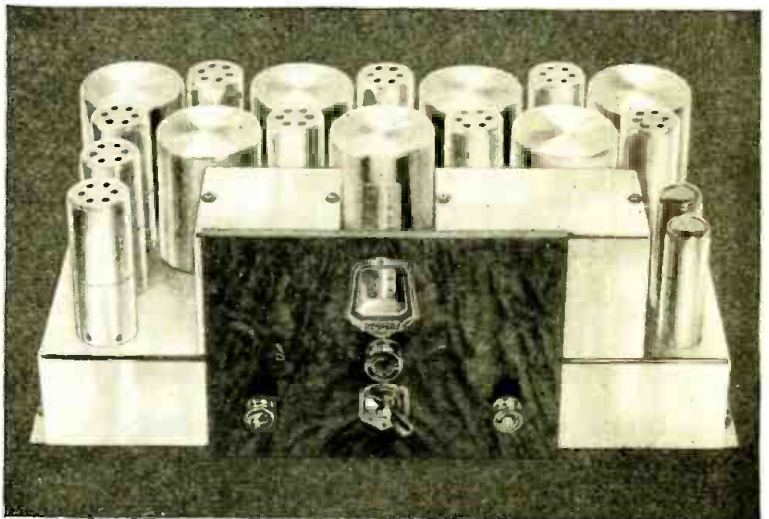

Our Challenge to the Radio World

Our tests show the performance of no other receiver even approaches that of the new SCOTT ALLWAVE DELUXE—A fact confirmed by laboratory measurements made by *independent* testing laboratories. Here's our Challenge—

1. Over eight years ago a SCOTT SUPER EIGHT brought in 119 programs from 19 different broadcasting stations, all 6,000 miles or more distant, and had all reception fully verified—**Who Can Equal THIS Record?**
2. Over 16,000 detailed logs of foreign station reception have been received from owners of SCOTT SETS since January 1st, 1932 from 257 different foreign stations in 43 foreign countries (Canada and Mexico logs not counted). **Who Can Equal THIS Record?**
3. Every regular program from station VK2ME, Sydney, Australia, 9,500 miles distant, has been logged and reception recorded for twelve consecutive months on a SCOTT ALLWAVE RECEIVER located in Chicago. **Who Can Equal THIS Record?**
4. Finally—What manufacturer claiming "record breaking performance" is willing to place his receiver alongside the new SCOTT ALLWAVE DELUXE for a competitive test on distant stations from 15 to 550 meters—the results of this test to be published in THIS magazine—Reception results to be judged by three or more leading Radio Engineers or Radio Editors—After reception tests, both receivers to be subject to tone test—Results to be judged by three or more well known musical authorities. **Who Will Accept THIS Challenge?**

THE E. H. SCOTT RADIO LABORATORIES, INC.
4450 Ravenswood Ave., Dept. C-92, Chicago, Ill.

Send me full particulars of the new SCOTT ALLWAVE deluxe.

Name

Street

Town

State

Again Midwest Offers the Season's Greatest Radio Sensation!

World-Wide Reception

Just a few excerpts from letters written by delighted Midwest owners. We have thousands of them on file. Mail coupon or write for new catalog and we'll send you ample PROOF of Midwest World-Wide reception.

Clarity! Selectivity Volume! Distance!

"To try and express our joy over the set we purchased from you would be a problem, but with the deepest sincerity we will deny anyone to pry it away from us.

"Clarity! Selectivity! Volume! Distance! Anything and everything one would care for in a radio. It surely is a beauty! Having visited your plant, I am at liberty to say I found it just like the radio. 'Ship-Shape'."

"May you enjoy many more years of success as I know you will with your 'direct from factory' prices."

P. G. Kurth, 2211 N. Booth Ave., Milwaukee, Wis.

France, England, Spain, Cuba, Hawaii

"We have always thought that our nine-tube radio was quite superior to most, but now that we have tried out the Midwest All-World, All-Wave, we are all for your set. There is nothing to equal its clear, life-like tone, selectivity and power to bring in distant stations as clearly as locals.

"Regarding the Short Wave, it comes way above our expectations. Police stations, testing stations, airports and amateur operators come in clearly at almost any time. We also get stations in France, England, Spain, Cuba and Hawaii."

D. M. Fish, R. F. D. No. 4, Ithaca, N. Y.

Germany, Italy, South America

"Have received the set and so far am very pleased with it. On broadcast it is exceptionally sharp. I live in the heart of the city with 42 broadcasting stations within 10 miles and the Midwest is surely giving results. KMON comes in like a local.

"As for short waves, received Germany last Sunday afternoon. Italy has also been heard and several South American Stations."

E. Joyce, 756 Home St., Bronx, New York City.

Likes Midwest Automatic Tone Control

"Reception on the regular broadcast set, in my opinion, is very hard to equal and I dare say impossible to beat on any set costing twice the amount of the Midwest. It is very sensitive and so selective that barely a touch of the dial knob and you have another station coming in clear and without interference. The automatic tone control is great. I am now able to hold many stations which before would fade out right in the best part of the program. I have not done very much 'fishing' with the short wave as yet, although I have listened to Bound Brook, N. J., Schenectady and Australia and a few others."

Archie J. Goss, 6th South 3rd West, Brigham City, Utah.

W8XK—W3XAL—WIXAZ
—W2XAF

"I am very much satisfied in every way with my Midwest radio. I heard Sydney, Sunday 3:00 A. M. Also W8XK, W3XAL, WIXAZ, W2XAF, in the evening. On the regular band have some 55 stations so far."

Aug. Balbi, 1427 Myra Ave., Los Angeles, Calif.

All-Wave

Regular Broadcasts--

Foreign Broadcasts—Police—Amateur—Ships at Sea—All With One Dial!

WHAT a radio! One complete 16-tube chassis with one DUAL-RATIO DIAL—new Super-Heterodyne circuit with a range of 15 to 500 METERS. . . . No plug-in coils—No Trimmers . . . and with the new STAT-OMIT tuning silencer you get in-between-station silence and perfect tuning without Neon lights, meters or buttons which were formerly necessary without this latest tuning circuit. . . . Large acoustically matched DUAL SPEAKERS. . . . New CLASS "B" PUSH-PUSH Super Power Amplifier with six times the power of ordinary tubes. . . . Full band AUTOMATIC VOLUME CONTROL. . . . COLORLITE Multi-Wave Band Selector giving instant choice of four distinct wave bands, regular broadcasts, foreign broadcasts, police and amateur. . . . FULL-FLOATING VARIABLE CONDENSER. . . . Complete Scientific Shielding. . . . Absolute tone fidelity. . . . Image Frequency Suppressor. . . . Fractional Microvolt Sensitivity. . . . 18 TUNED CIRCUITS. . . . NEW TYPE TUBES, 29, 56, 57, 58, 42, 46 and 82 tubes. . . . SUPER TRIODES, DUAL AND TRIPLE GRIDS, Two Full Wave Rectifiers including the new Mercury type, DUAL POWERED, two separate power transformers. A bigger, better, more powerful, more selective, finer toned radio than you've ever seen before . . . offered at an amazingly low price direct from the big Midwest factory. Midwest engineers have far outdistanced all past performances in perfecting this new set.

DEAL DIRECT with FACTORY! Save the Middlemen's Profits

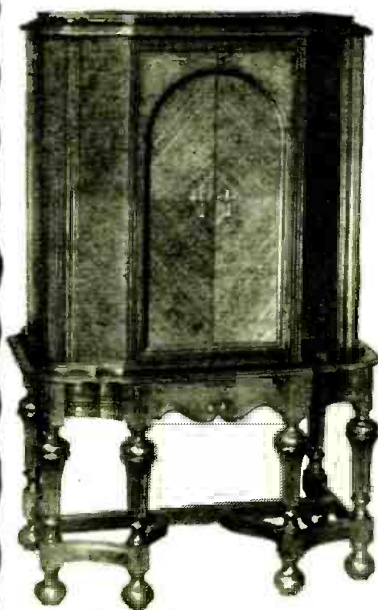

Complete Line of Beautiful New Consoles

The big new Midwest catalog shows gorgeous line of artistic consoles in the new six-leg designs. Mail the coupon or write us a postal. Get all the facts. Learn how you can save 30 percent to 50 percent on a big powerful radio by ordering direct from factory.

Midwest methods of production effect large economies and give radio fans bigger and better radios for less money. And when you get this big, powerful Midwest 16-TUBE set you get ALL that the radio world can offer you—great range, perfect tone, amazing selectivity, tremendous reserve power, sensationally low cost of operation. Don't be satisfied with less than a Midwest 16-tube all-electric set. Broadcast listeners are coming to realize that a receiver covering only the regular broadcast waves is only half a set. This amazing new Midwest gives you regular, foreign, police and amateur broadcasts in one single dial set. No converter or any extra units required. Improvements in short-wave receivers and programs have made ordinary broadcast sets obsolete. In selecting a set, choose one that is not only good today but will be in step with tomorrow.

PAY As You PLAY!

Remember, you buy DIRECT FROM THE MAKERS. No middlemen's profits to pay. You get an absolute guarantee of satisfaction or money back. You try any Midwest 30 DAYS before you decide to keep it. Then, if you wish, you can pay for your set in easy monthly amounts that you'll scarcely miss. Besides, you can make easy EXTRA money as our USER AGENT. Coupon brings full details—mail it NOW!

TERMS
as low as
\$5.00
DOWN

Mail the Coupon!

Investigate! Mail the coupon. Get the Midwest catalog. Learn the facts about Midwest 9, 12 and 16-tube ALL-WAVE sets. Learn about our sensationally low factory prices, easy payment plan and positive guarantee of satisfaction or money back. Save up to 50 percent on your new radio!

MIDWEST RADIO CORP.

16-Tube *Only* **39.95**

Completely Assembled with Large **DUAL SPEAKERS**

Save UP TO 50%



New 1933 Features

New Class "B" Push-Push Power Amplifier. . . . Stat-Omit Tuning Silencer. . . . Color-Lite Tuning. . . . Full band automatic Volume Control. . . . Triplex Duo-Diode Detection. . . . Dual-Ratio Single Dial. . . . No Trimmers, No Plug-in Coils, No tuning meter or Neon light required. . . . Fractional Microvolt Sensitivity. . . . Dual Powered (2 separate Power Transformers). . . . Absolute Tone (30 to 5200 cycles). . . . 18 Tuned Circuits. . . . New Mercury Rectifier. . . . Full-Floating Variable Condenser. . . . Low Operating Cost. The new Midwest 16-tube set actually uses less current than previous sets of 8 and 10 tubes. . . . Uses the new type tubes, 29, 56, 57, 58, 42, 46, 82. . . .

30 DAYS FREE TRIAL

Remember, every Midwest set is backed by a positive guarantee of satisfaction or your money back. 30 DAYS' FREE TRIAL in your own home makes you the sole judge. Midwest, now in its twelfth successful year, offers bigger, better, more powerful, more sensitive radios at lower prices than ever before. The coupon or a postal card brings you big new information. Mail it NOW!

Every Improvement That Makes for Better Reception

BATTERY RADIOS

Using the New AIR CELL BATTERY

Two sensational values: a 6-tube super-het for standard-wave reception and a 9-tube ALL-WAVE, both using the new AIR CELL "A" battery that never needs recharging. Low factory price. Coupon brings details. Mail it NOW!

Nothing has been overlooked and nothing important omitted in the new Midwest 9, 12 and 16-tube ALL-WAVE A.C. sets. You'll be amazed and delighted with the volume, the ease of control, the amazing clarity of reproduction and the absence of frying and cracking noises. Such radio reception has never before been known. Don't buy a set of any kind until you get the big new Midwest catalog. Mail the coupon now. Learn how you can save 30 percent to 50 percent direct from the factory—and buy on easy terms to suit your convenience.

Get All the Facts NOW

RUSH THIS COUPON FOR AMAZING FREE TRIAL OFFER AND BIG BEAUTIFUL CATALOG

USER AGENTS
Big money in spare time. Check here for details.

Midwest Radio, Corp., Dept. 110, Cincinnati, Ohio. Gentlemen: Please rush my copy of your big, beautiful, new catalog and complete details about the powerful, new 9, 12, and 16-Tube ALL-WAVE super-heterodyne outfits. I am not obligated.

Name Street Town State

Dept. 110, **CINCINNATI, OHIO**

96 PAGES

OF NEW DATA HAVE
BEEN ADDED TO THE

OFFICIAL REFRIGERATION SERVICE MANUAL

To bring this useful service manual right up-to-date, Mr. L. K. Wright, the Editor of the OFFICIAL REFRIGERATION SERVICE MANUAL, has added a wealth of entirely new material on electric refrigerators. This new section, which totals 96 pages, has contained therein dozens of new models of recent manufacture which have been placed on the market during the past few months and in addition, information regarding improvements on older models. As usual every refrigerator has been accurately described from the viewpoint of servicing—diagrams to illustrate the essential parts, and simplified so that repairs can easily be made

NO EXTRA COST FOR THIS MATERIAL

The addition of these new pages will not increase the cost of the book to those who order their copy now. With the inclusion of more pages, the OFFICIAL REFRIGERATION SERVICE MANUAL will have over 1,200 diagrams and over 450 pages. Its flexible, loose-leaf binder accommodates the extra pages very easily. When the material has been placed in the manual, you will have a complete 1931-1932 OFFICIAL REFRIGERATION SERVICE MANUAL.

Radio Service Men—Turn Idle Summer Hours into Profit by Servicing Electric Refrigerators with the aid of this New and Complete Service Manual.

THE idea of electricians, radio service men and other mechanically inclined men, servicing refrigeration units is self-evident and the thought has occurred to perhaps untold thousands ever since electric refrigeration started. Yet nothing was done, because the average man knows little or nothing about refrigeration. Compared with servicing a radio set or wiring a home for electricity, the servicing of a refrigerator is absurdly simple, once you get the hang of it.

The OFFICIAL REFRIGERATION SERVICE MANUAL has been edited by L. K. Wright, who is an expert and a leading refrigeration authority. He is a member of the American Society of Mechanical Engineers, American Society of Refrigeration Engineers, The National Association of Practical Engineers, etc.

In this Refrigeration Manual every page is profusely illustrated; every refrigerator part is carefully explained; diagrams are furnished of every known machine; special care is given to the servicing end. The tools needed are illustrated and explained; there are trouble shooting charts, and other service data.

Remember there is big money in the refrigeration servicing business. There are thousands of firms selling refrigerators every day and they need to be cared for often. Eventually there will be more re-

frigerators than radios. Why not increase your earnings with a full or spare time business by servicing refrigerators.

Here are some of the important chapters:

- Introduction to the Refrigeration Servicing Business
- History of Refrigeration
- Fundamentals of Refrigeration
- Description of All Known Types of Refrigeration.
- Service Tools and Shop Equipment
- Motors
- Trouble Shooting
- Unit Parts, Valves and Automatic Equipment
- Makes and Specifications of Units
- Manufacturers of Cabinets
- Refrigerants and Automatic Equipment
- and Many other Important Chapters.

Several thousands of copies of the OFFICIAL REFRIGERATION SERVICE MANUAL have been sold; and there still remains the greatest opportunity for thousands more to learn how to make more money in a short time through openings in this new field.

NOW ..

OVER 1,200 DIAGRAMS

450 Pages

Flexible Looseleaf Binder

Complete Service Data

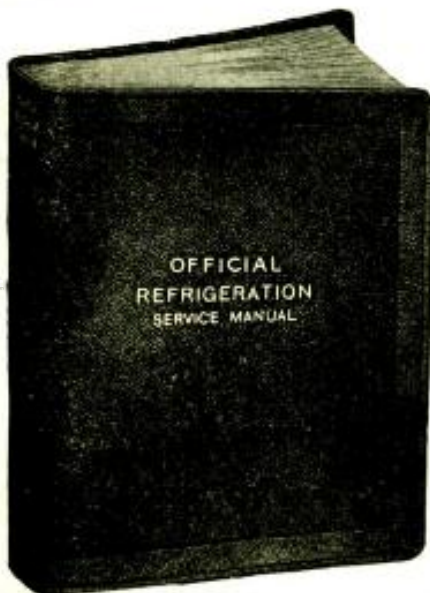

**THE FIRST COMPLETE
REFRIGERATION SER-
VICE MANUAL
PUBLISHED.**

**Clip and Mail Coupon
TODAY!**

GERNSBACK PUBLICATIONS, Inc. RC-932
96-98 Park Place, New York, N. Y.

I enclose herewith my remittance for \$5.00 (check, stamps or Money Order accepted) for which you are to send me, postage prepaid, one copy of the OFFICIAL REFRIGERATION SERVICE MANUAL, together with the extra 96 pages of new material at no extra cost.

Name

Address

City..... State



Takes the Resistance Out of Radio"

Editorial Offices: 96-98 Park Place, New York, N. Y.

HUGO GERNSBACK, Editor

Vol. IV, No. 3, September, 1932.

WHAT IS WRONG WITH TELEVISION?

An Editorial by HUGO GERNSBACK

MANY people are disappointed with the present status of television. They seem to deplore the fact that, although we have had television "out of the laboratory" for several years, the public has not plunged head over heels into it the same as they did in 1922 when broadcasting started. We have been told time and again that television is just around the corner when, actually, that statement needs correction because television is no longer around the corner but is actually here.

What then is wrong with television? Fundamentally, there is nothing wrong! It is rather the impatience of the people in general that might be termed wrong. If television had preceded aural broadcasting, in 1920, we probably would have had the same kind of a boom in television. The trouble is that the public has been led to believe by the daily press and other authorities that television was created over night, and that for \$5.00 you can construct your own television set and view all sorts of interesting events.

This impatience of the general public is understandable because, in 1922 you could, for a few dollars, build a crystal receiver and receive most excellent music from quite a few radio stations. But the art of television has not advanced so far. We cannot, yet, receive images as clearly and distinctly as we received messages and music in 1922. It should be remembered that the crystal detector and other instrumentalities of radio had been with us from 1908, some 14 years before the broadcast boom got under way. During those fourteen years, radio engineers had sufficient time to develop radio to a fairly high standard, and when the broadcast stations sprang up in 1922-1924, all the instrumentalities, crude as they were, were on hand to further the boom.

Television has been with us for only a few years, and the public has been able to buy discs and scanners and television tubes only in the past two or three years. Coupled with this is the fact that the Federal Radio Commission, after some ten years' experience with radio, is treading a cautious road, and is not handing out licenses to new stations without due deliberation. Moreover, the Radio Commission will not allow commercial programs to be broadcast by the television stations; which makes it impossible at the present time to give the sort of program that can compete with aural radio. Consequently, the television programs offered now are in most cases mediocre, and only of an experimental nature. To be sure, progress is being made, and the programs are improving from month to month; but it will be sometime before they can compete with aural radio programs.

But perhaps the greatest drawback in television is the present cost of the television receiver. It is necessary to have, first, a television receiver which must have at least five tubes; or you must have a short-wave converter, which, admittedly, is only a makeshift because it does not give

as good results as a straight short-wave television receiver designed for that purpose. As things stand today, a television short-wave receiver runs into quite a bit of money, and costs at least twice as much as a regular radio set.

On top of this, it is then necessary to buy a television scanning mechanism, composed of an electric motor, scanning disc, neon tube, etc., all of which runs the cost up much higher than the 1922 crystal set. This, perhaps, is the major reason, why the public has not taken to television with as much avidity as it took to radio.

Then too, there are not nearly as many television stations in the country as there are regular radio broadcasting stations. At the present time there are only 24 television stations against some 550 broadcast stations. This brings about the situation that, in most localities in the United States, it is difficult to receive television signals unless you have an exceedingly powerful set.

Then too, there is the matter of synchronization; because, if the television transmitter is not on the same electrical power system as the television receiver, the image on the receiver is apt to "drift," and must be manually corrected, which is not a welcome feature.

Of course, all these objections are not absolutely vital because, after all, it is possible, even today, in 80% of the locations in this country to receive television programs with a fair degree of success. Of course, it is not claimed that the results are as good as those of audible radio, but remember that television is as yet very young, and it is quite wonderful to do as well as we do at the present stage of the art.

There may also be reluctance on the part of the public, at the present time, about buying television equipment because they feel that whatever equipment they buy will be obsolete within three months. This is not necessarily true. On the contrary, it seems certain that present-day television equipment will be in use two years hence, because nothing is apparent on the horizon that will effect a revolution over night. Even the advent of the much-heralded cathode-ray tube will not make the disc television receiver obsolete. The chances are that, for years to come, the television disc and cathode-ray tube will work side by side.

When the vacuum receiver came along, it did not throw into the discard all the crystal receivers. Quite to the contrary, for it is a surprising fact that even today, there is an excellent market for crystal sets. Strange as it may seem, thousands of crystal sets are sold every month, even in the United States, to people who cannot afford to buy a regular radio receiver.

There is nothing wrong with television today! Give the art time, and it will work out its own salvation, just as radio did; and, if you are interested in television, the time to buy a set is NOW, because the chances are nine to one that next year's developments will not be of such a nature that they will render your present-day set obsolete.

THE RADIO-CRAFT UNIVERSAL ANALYZER

By THE ENGINEERING STAFF OF RADIO-CRAFT

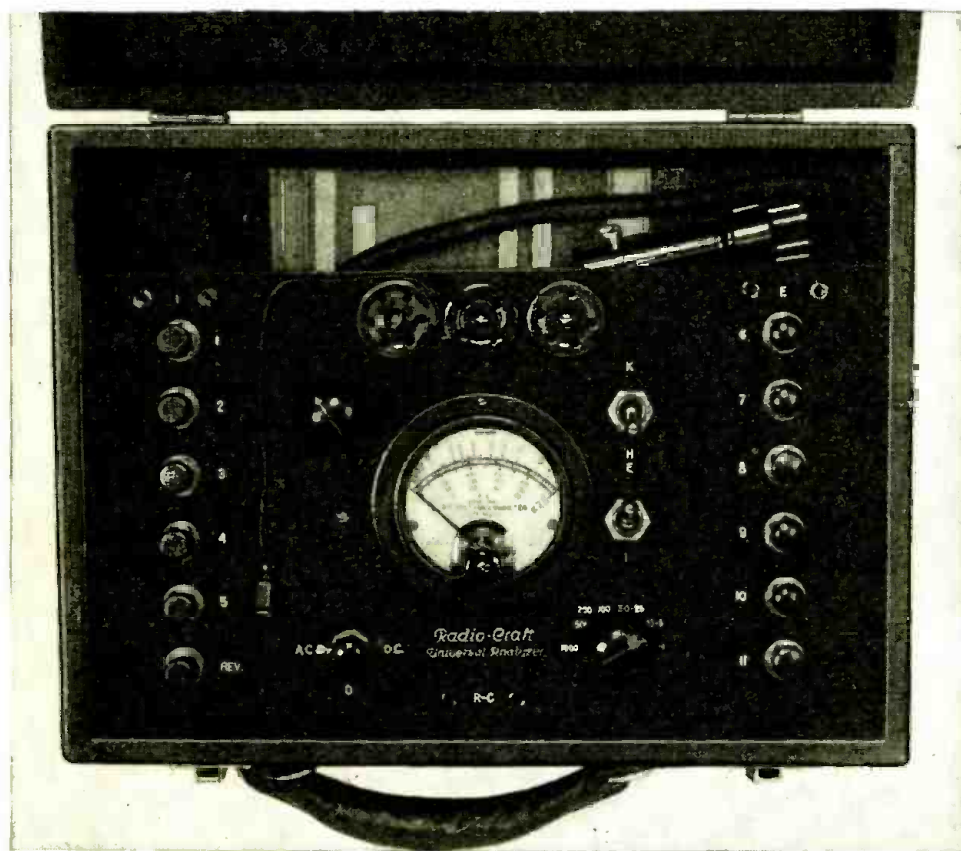

Fig. A
Front view illustrating the location of the push-buttons, meters, etc.

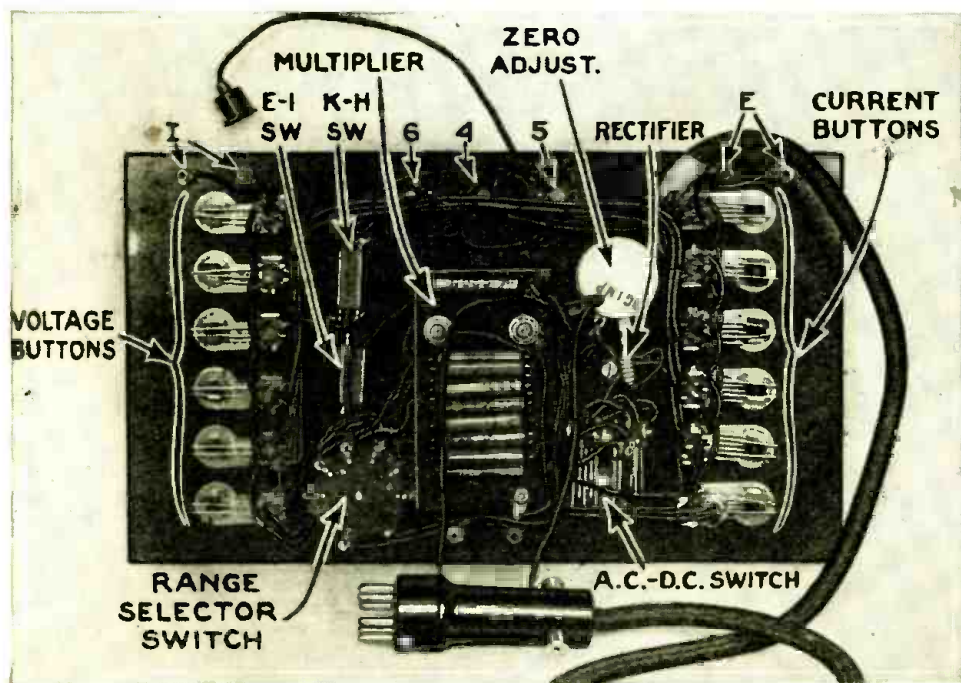

Fig. B
Rear view of the analyzer. Note the use of cable wiring and the use of the sub-panel, mounted on the meter, for holding the multipliers.

● For the past year we have been deluged with inquiries regarding constructional data of a modern set analyzer. To satisfy our readers, we have designed and constructed the RADIO-CRAFT Universal Analyzer described in this article.

It is universal in its use—hence its name—and is capable of testing any receiver using the latest tubes available and many which are not as yet available. It may be built for about \$28.00 complete, and for the man who desires to build his own, we heartily recommend it.

MODERN radio receiver and tube developments place new demands upon the radio set analyzer, especially since tube manufacturers have introduced the six (and perhaps the seven!) prong base. A glance at the July issue of RADIO-CRAFT (tube chart) will convince any Service Man that corresponding connections of the elements of different tubes vary widely. In most of the screen-grid tubes, the cap connects to the control-grid, while in the Wunderlich five-prong detector, the cap connects to the cathode.

This means (1) that a set analyzer designed for screen-grid tubes will not test the Wunderlich; (2) present-day analyzers have no provision for testing the pentode grid (now called suppressor) circuit; and (3) if adapters are used, a button marked *control grid* may have to be pressed in order to read the plate voltage on a particular tube. In other words, to bring the present-day set analyzer up-to-date, the entire analyzer must be rewired to handle not only existing tubes but with a minimum of labor, all future models. This is exactly what RADIO-CRAFT UNIVERSAL ANALYZER DOES.

Description of Our Analyzer

With the requirements for satisfactory and rapid servicing in mind, the staff of RADIO-CRAFT set about to design the tester illustrated in the accompanying sketches and photographs. Keeping in mind the fact that the average Service Man may be low in funds, the cost of the completed unit was carefully calculated, at the same time using the highest quality of parts, until a unit was developed costing about \$28.00 which was far less than expected by the Staff.

A glance at the photographs will show that push buttons were used throughout,

with the exception of the range-selector switch. This arrangement reduced the complexity of the wiring and the cost to a minimum.

Since any form of lettering for indicating meter connections could not be used because of widely varying socket connections, a numerical designation was decided upon. A glance at Figs. A, B and C will show this. Refer to Fig. A. At the upper left-hand end of the panel are two tip jacks marked "I." These two terminals are for external current measurements. Directly under these tip jacks is a row of six buttons labeled from 1 to 5 inclusive, the last one labeled "REV." The first five numbered buttons are for current readings only, the "REV." button only reversing the connections to the meter when desired.

Directly to the right of the "I" tip jacks are three sockets, a six-, a four- and a five-prong. To the right of these and in line with the "I" tip jacks are two more tip jacks labeled "E." These tip jacks facilitate the external measurement of voltage only. Directly under them is a row of buttons marked from 6 to 11 inclusive. These buttons are for voltage measurements when the instrument is used as an analyzer.

At the lower edge of the panel, at the center, are two more tip jacks marked "R-C" which are for resistance continuity work. To the left and a little above the "R-C" jacks is a toggle switch marked "A. C." on one side and "D. C." on the other. This switch is thrown to the side corresponding to the type of voltage or current to be measured. Directly above this switch is a knob with an arrow on it. This knob is used to adjust the meter to full scale when resistance measurements must be made.

To the right of the meter are two toggle switches, one a "K to H" (cathode to heater) connection and the other an

"E to I" switch. The latter should be thrown to the "E" side when voltage measurements are to be made and to the "I" side when current is to be measured.

Directly under these toggle switches is the range selector switch. The markings are as follows: 1,000, 500, 250-100, 50-25, 10-5, 5-1. When on the first or "1,000" tap, the range of the meter is 1,000 volts full scale (at 1,000 ohms per volt); when on the "500" tap, the range of the meter when used as a voltmeter is 500 volts and when used as milliammeter is 500 milliamperes; on the "250-100" tap, the voltage range is 250 and the current range is 100 ma.; on the "50-25" tap, the voltage range is 50 and the current range is 25 ma.; on the "10-5" tap, the voltage range is 10 and the current range is 5 ma.; on the "5-1" tap, the voltage range is 5 and the current range is 1 ma.

It should be pointed out that the above voltage ranges are for either D.C. or A.C., depending upon which side the "A.C.—D.C." switch is thrown.

Figure 1 is the diagram of connections. The six-prong cable is shown to the left and the set of switches shown directly to its right are the current buttons, drawn vertically. The switches drawn horizontally are the voltage buttons. The socket connections represent the location of the prongs when looking down on the socket from above. Two sets of voltage multipliers are used, one for A.C. and the other for D.C. as shown. In this manner the accuracy of measurement is maintained well below 5 percent for both A.C. and D.C. ranges. The remainder of the diagram is self-explanatory.

Figure 2 indicates the mechanical layout of the panel. All dimensions are given and the reader should have no difficulty in constructing this instrument. Reference should be made to the photographs when assembling the tester as they are clearly

marked for this purpose.

Using the Analyzer

A.C. MEASUREMENTS: Turn the switch marked "A.C.—D.C." to the A.C. position. The toggle switch marked "I—E" should be in the E position. This removes the current shunts from the meter circuit and reduces possible danger. For example, if the operator should push one of the current buttons (Nos. 1 to 5) no indication will appear on the meter scale.

Be sure that the voltage range selected for the test is *greater* than the voltage present in the circuit. It is best to start with the 1,000-volt scale and then change to the scale which gives a reading in the center of the dial.

Do not try to read D.C. voltages on the meter when the A.C.-D.C. switch is on A.C.

The voltage scales on the meter are indicated with heavy black lettering and the A.C. scale is laid out above the center arc with a compensated scale to correct for the non-linear action of the rectifier. As one becomes familiar with the scale, its simplicity and accuracy will be appreciated.

D.C. MEASUREMENTS: Turn the switch marked "A.C.—D.C." to the D.C. position. The toggle switch marked "I—E" should be in the E position. This removes the current shunts as described in the section above.

It is impossible to read A.C. voltages on the D.C. scale because the rectifier is removed from the circuit.

Be sure that the voltage range of the meter is greater than the voltage present in the circuit. Start with the 1,000-volt range and work down until the reading falls near the center of the dial.

The D.C. voltage scales are located on the lower portion of the dial of the meter and there is no correction for them.

The accuracy of the readings on the D.C. scales are limited by the accuracy

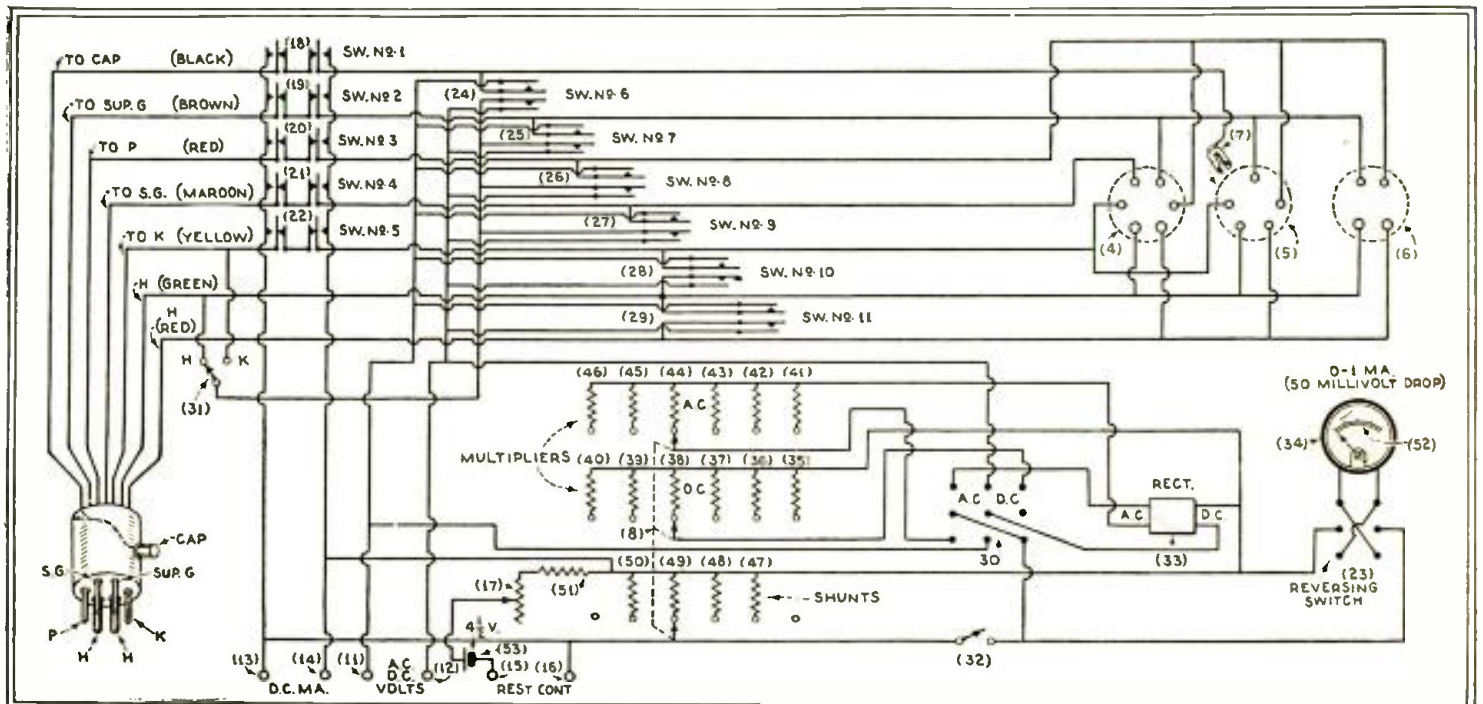

Fig. 1
Complete schematic circuit of the analyzer. The numbers in parentheses are parts numbers and their values are given in the article.



Fig. C
The RADIO-CRAFT Universal Analyzer in action.

of the meter, the multipliers and the ability of the operator to read it correctly. The selection of accurate resistors and good electrical connections between the parts are important considerations and should be handled accordingly.

TESTING RADIO RECEIVERS: A 6-prong plug with a three-foot cable is used to complete the circuits between the receiver and the analyzer. If the receiver is equipped with 5- or 4-prong sockets, there are two adapters which clip to the 6-prong plug. One changes the 6-prong plug to a 4-prong and the other changes the 6- to a 5-prong. The clip connecting to the cap has a connecting point on the barrel of the plug.

When current measurements are being made, it is advisable to keep the three-way switch (The A.C.—O—D.C. switch is also called the A.C.—D.C. switch in this article) in the "O" position. By so doing, all the push buttons on the right-hand side are disconnected. Thus, if a current button and a voltage button are pressed at the same time there will be but one deflection—this deflection will be some value of current.

All readings necessary for the proper determination of circuit conditions can

be found by pressing the proper numbered button on the analyzer after referring to the chart which lists more than 40 types of tubes, both old and new.

The fact that any voltage or current scale can be used in connection with any of the tube circuits permits of the greatest elasticity of circuit tests. For example, voltages up to 1,000 can be measured in the normal control-grid circuit of the tube under test. Also plate currents or grid currents up to 500 ma. if so desired. Any circuit of the tube can be measured provided the voltage and current ranges of the multipliers and shunts are not exceeded.

RESISTANCE MEASUREMENTS: The two black insulated tip jacks in the front and center of the panel are, as mentioned previously, for resistance and continuity measurements. The 4.5-volt "C" battery is used in conjunction with a 1,000-ohm rheostat and a 4,000-ohm fixed resistor for continuity and measurement of resistors of values up to 100,000 ohms. A direct-reading scale is provided on the meter for this purpose; this is the upper scale on the meter.

To place this portion of the analyzer in operation, it is necessary to short-circuit the test prods connected to the tip jacks and adjust the reading of the meter to full scale. The voltage-current selector switch should be placed in the 1. ma. position. *If this is not done the readings will be false.*

WHEN USING THE METER FOR RESISTANCE OR CONTINUITY MEASUREMENTS DO NOT HAVE THE ANALYZER PLUG CONNECTED TO A RADIO SET.

While the design is such as to limit the possibility of the meter or rectifier burning out, care should be exercised at all times. The better the instrument the more careful one should be.

OUTPUT METER: The A.C. Voltmeter may be used as an output meter where such a device is required. The use of a voltmeter as an output meter is very

satisfactory for testing and aligning the coil-and-condenser units in tuned radio frequency and superheterodyne circuits. A constant signal should be supplied to the receiver and the proper voltage range on the output meter selected. The normal ranges on the A.C. voltmeter are available for this purpose.

Construction

The panel is of black bakelite, 7 x 12 x 3/16 inches, and is drilled and engraved as shown in the mechanical drawing. All parts are mounted on the panel except the bakelite strip holding the resistors for the multipliers and shunts.

The resistors are mounted on this strip which, after the rest of the wiring has been completed, is fastened into place by bolting it to the large screw connections serving as terminals for the meter. This provides ample support for the resistor strip and locates the resistors near the selector switch.

All the voltage feed-wires can be made with No. 18 or larger copper wire. The insulation of this wire should be of the best. No leakage should or can be permitted between the wires if satisfactory operation is to be secured. The filament leads in the connecting cable should be No. 14 or larger to prevent large voltage drops in the leads.

Care should be taken in wiring the current circuits; use bus-bar for all connections between the selector switch, shunts and the meter. Use the largest and best insulated wire which you can obtain.

Keep the three-foot cable connecting the analyzer to the radio set in good condition. Use the best cable you can secure. It pays in the long run and reduces the actual error which will be found in long cables and leads that have high resistance.

Carefully clean every soldered connection with alcohol. Do not let dirt or poor connections interfere with success.

The box in which the Universal Analyzer is carried is large enough to provide space for storing the small 4.5 volt "C" battery used for the continuity and resistance measurements, the set analyzer plug, the cable and extra leads for additional tests.

The same pair of leads used for the continuity tests may be used for the output-meter connecting wires, and it is wise to have clips on the ends of these leads as it is sometimes difficult to make permanent connections to the average voice-coil or voice-coil transformer.

Naturally, the success of such a unit as this depends on the care used in the assembly and the quality of the materials selected. Considering the accuracy of the unit as a whole and the absolute flexibility of measurement, the cost in time, labor and materials certainly justifies itself.

How to Use the Tube Chart

Suppose it is desired to analyze a receiver. The plug of the analyzer cable is inserted into one of the tube sockets in the
(Continued on page 183)

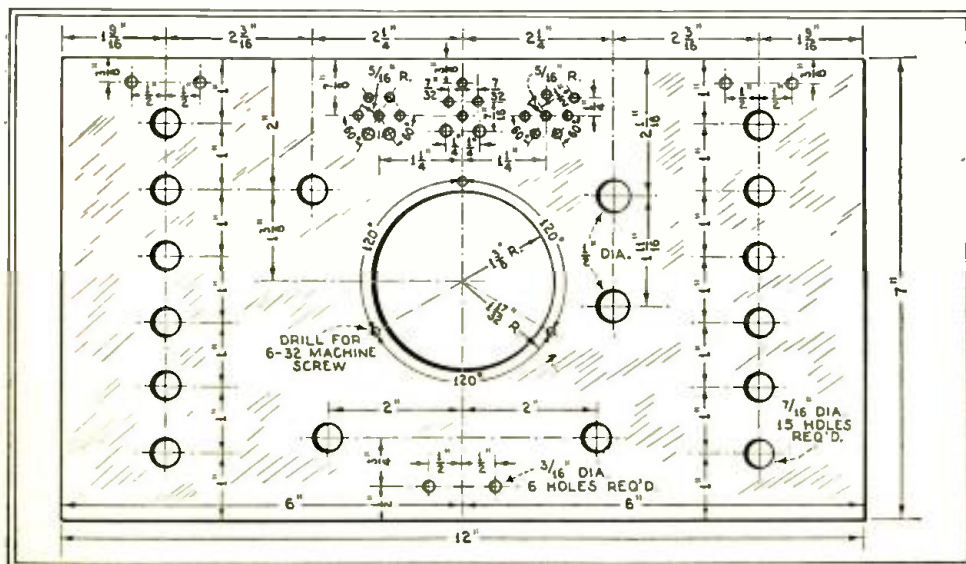

Fig. 2
Mechanical layout of the panel. The location of all the holes are clearly indicated. Of course, the dimensions are only valid if the parts specified are used.

A NEW LAPEL MICROPHONE

Some of the innermost secrets of the lapel microphone, its associated amplifier, and characteristics are revealed for the first time in this first of a series of articles.

By DR. IRVING J. SAXL*

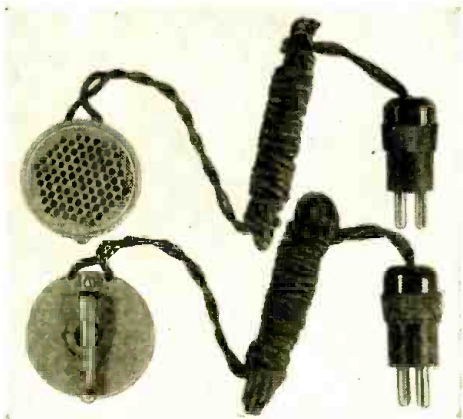

Fig. A
Above, front and rear views of the lapel mike. Note the rigid construction and small size.

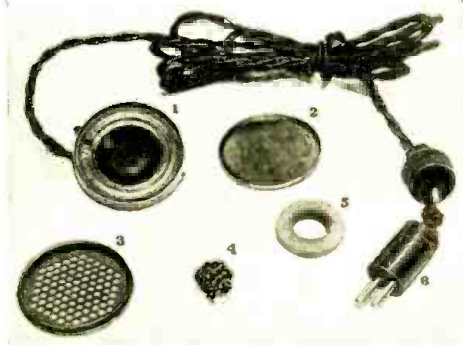

Fig. B
Close-up of the mike. The front shield is indicated at 3; the diaphragm at 2; the case at 1; the carbon granules at 4; and the felt washer at 5.

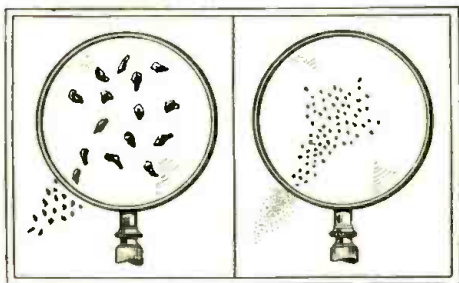

Fig. 2
Two species of carbon granules.

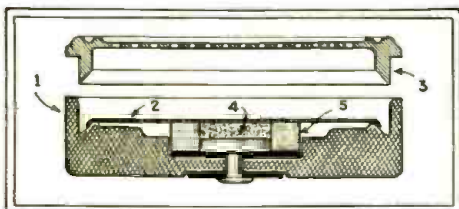

Fig. 1
Cross-section of the new lapel microphone. The numerals correspond to those of Fig. B. above.

PACING up and down the platform at a public convention, the speaker addresses his audience. Now he is at the left side of the hustings, now he is six feet away at the other side of the platform speaking to another part of the hall. His voice thunders from twenty loudspeakers distributed all over the convention hall, clear, natural and without the usual disturbing background noise known all too well to men who have

*Consulting Physicist.

worked with microphone pickups at public assemblies. How has this been done?

There must be some kind of sound reception but the astounded radio expert remarks the lack of microphones near the speaker. The quality of the sound is, indeed, excellent and the speaker may now move freely about the platform and be heard all over the hall. Compare this with a picture showing an old time pickup, where the speaker's face is hidden by a row of microphones and where he must remain practically without movement so that his voice may "go over" well. A decided improvement has been made, and there is no clumsy parabolic reflector for distance reception either. No microphone is visible, the speaker moves around freely, the sound quality is excellent, without background noise... how has it been done?

Lapel Microphone Used

The microphone, so mysteriously hidden from the audience, is of the lapel type. A small microphone, not larger than a button, is worn upon the lapel of the speaker's coat like a buttoniere, or it may be hidden under his coat, for instance, by attaching it to the watch pocket. The invisibility of the pickup is not only important from the point of view that it leaves the face of the speaker visible to the audience, but also because the advantages of electric pickup and amplification may be used in churches and other places where any mechanical instrument must be as inobtrusive as possible.

Figure A shows a close-up picture of a new microphone of this type in natural size. We see that it is approximately the size of a button. On the back of this button, (which is plated with oxidized silver) is a clip with which it can be attached to the lapel, or should it be desired, it can be worn entirely invisible, inside the dress. Only a thin cord, about twenty feet long, connects the orator to the reproducing system. It is now obvious why the sound of the speaker's voice is prevalent above the background noise of the

entire hall. This microphone is constructed in such a way that it reacts only upon sounds from the immediate neighborhood, without having any appreciable distance sensitivity. Thus, the voice of the speaker is continuously picked up from this microphone which is about seven inches from his mouth, and also resonates with the speaker's diaphragm while other sounds are not picked up by the amplifying equipment. Thus the background noise is reduced to a minimum.

Constructional Details of Microphone

While it is relatively simple to get microphonic action from almost any material, the "good old times" of the carbon rod microphone (consisting simply of two hollow carbons with a stick between) have passed definitely. We now expect from a microphone a natural sound response over a range of at least 25 to 8,000 cycles, and for bringing about this effect, considerable engineering and scientific work had to be done. Though appearing simple in its final construction, such a microphone is built with as much precision as is required in building a watch, and its parts are standardized in such a way that even the slightest variation brings about an impairment in the acoustical reproduction. This is why the amateur, otherwise so important in the development of the various fields of the electronic sciences, was unsuccessful in this branch of the science before the manufacture of efficient lapel microphones was undertaken by specialists with precision tools.

Figure B shows a close-up of the inside of the microphone and the parts used within it. We see, in the center of the case, (1) a black circle. This is a glazed carbon button which consists of a specially prepared carbon disc connected conductively to a metal plate. This carbon button is highly polished and must have great hardness. It must be a special carbon, the composition of which has been developed through persistent scientific re-

(Continued on page 171)

STILL MORE NEW TUBES!

Detector and power-output tubes predominate in the new offerings by tube manufacturers. Described below are six new tubes designed for various classes of service.

By LOUIS MARTIN



Fig. A
The 55; Duplex-Diode
Triode.



Fig. B
The ER-49; a 2-volt
Pentode.



Fig. C
The new BR rectifier.



Fig. D
The 43; a pentode.



Fig. E
The 29 and 69.



Fig. F
The TS-257; a pentode.

PAST issues of RADIO-CRAFT contained considerable data on the application and theory of the more recent tubes. In the past month, tube manufacturers have announced an entirely new series of tubes suitable for R.F. amplifiers, detectors, oscillators, and output work. In this discussion, we will attempt to present before the readers a brief description of the characteristics and uses of new tubes announced during the past month.

The 55—Duplex-Diode Triode

The April 1932 issue of this publication contained a description of the Wunderlich tube. Briefly, this tube was equipped with a heater, a cathode, two coplaner grids, and a plate. Diagram of connections, given in the above mentioned article, indicate that the input circuit of this tube is connected exactly as any ordinary push-pull or push-push amplifier. Some of the advantages of this tube are the facts that (1) a balanced input circuit is secured; (2) total absence of R.F. in the plate circuit, thus obviating the necessity for a filter system and also preventing oscillation in this stage; (3) grid circuit rectification and triode amplification in one tube (the μ being about 12); (4) the D.C. component secured in the grid circuit may be used in an automatic volume-control system. Thus, it may be seen that this tube is a combination diode detector, triode amplifier, and A.V.C. tube.

The 55 recently announced is not unlike the Wunderlich device. An inspection of the photograph, Fig. A, reveals several interesting features.

Of particular importance are the peculiar shaped metal plates surrounding the cathode and placed between the two mica discs shown. These two plates, in conjunction with the cathode which it surrounds, form the diode-detector part of the tube. In other words, each of these diode plates makes a connection to a pin on the base, and is connected exactly as the two grids in the Wunderlich tube. That is, while one plate is positive, current flows from the cathode to one of the plates, the reverse taking place on the other half of the cycle. This accounts for two of the prongs of the six prong base. The heater and cathode connection accounts for an additional three prongs; and the plate for the sixth. The

cap on the top of the tube connects to the single grid, which in construction, is exactly the same as the grid in a '27.

We now have between the two mica discs a full-wave diode rectifier. Directly above the upper disc, and surrounding the aforementioned cathode, is an ordinary control grid which, as stated before, connects to the cap of the tube. This section of the 55 is an ordinary three element tube and circuit arrangements for the connection of the entire tube are shown in Fig. 1. In Fig. 2A a detailed drawing shows the location of the diode plates with respect to the remainder of the elements, and in Fig. 2B the socket connections of the 55 looking up from under the socket are shown.

A typical diagram of the use of the 55 is illustrated in Fig. 1A. The secondary of the tube circuit connects directly to the two diode plates. The current flowing as the result of an applied signal causes a voltage drop across resistor R1 and condenser C1. This voltage, being applied between the cathode and the center tap of the tuned secondary which also connects to the grid of the tube, actuates the triode section of the tube in the usual fashion, thus producing an audio voltage across resistor R3. If A.V.C. action is desired (especially delayed A.V.C.), the resistor R2 is inserted which connects, as shown, to the R.F. grids.

Condensers C3 and C4 are inserted for bypassing purposes. Fig. 1B is a sketch of a full-wave detector and A.V.C. arrangement with a fixed bias on the triode. R4 and C2 are approximately .5-megohms and .01-mf. respectively. They constitute the bias resistor and bypass condenser for same. At C of the same figure is shown a half-wave detector and A.V.C. arrangement with the triode "diode biased." In other words, the control grid, instead of being connected to the center tap of the coil, connects directly to one end of R1. Ordinarily, R1 is a grid leak but now functions also as a bias resistor for the grid. D shows a half-wave detector and an A.V.C. arrangement with a fixed bias on the triode. This is similar to that described at C with the exception that an additional resistor is used to supply the bias for the triode grid, thus making its action entirely independent of the strength of the applied signal. At E is shown a rather unusual arrangement

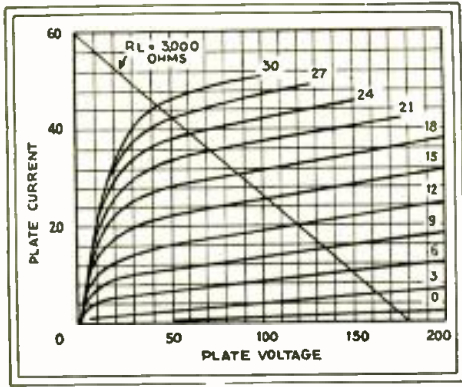

Fig. 3
Family of curves in class B operation.

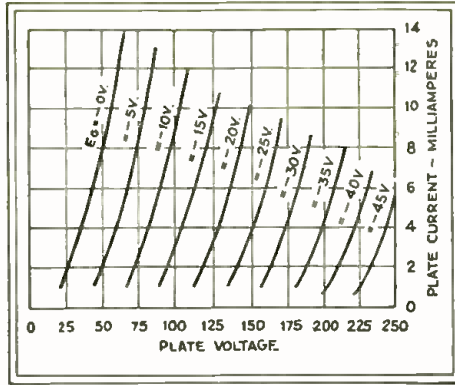

Fig. 4
Family of curves in class A operation.

whereby one diode serves as a half wave detector, the other diode as A.V.C. tube and the triode as an amplifier with a fixed bias; the use of a voltage Eb for sensitivity control is also illustrated.

The diode plate 1 serves as a detector while diode plate 2 is used for the A.V.C. It is recommended that whenever fixed biases are used such as at B, D, and E, the output of the tube be coupled to the succeeding one by a transformer rather than by a resistor. When used as a half-wave rectifier, approximately twice the A.V.C. voltage will be obtained as compared with the full-wave arrangement. The characteristics of this tube are as follows: Heater voltage, 2.5 A.C. or D.C.; heater current, 1 ampere; plate voltage, 250; grid voltage, -20; amplification factor, 8.3; plate resistance, 7500 ohms; mutual conductance, 1,100 micromhos; plate current, 8 ma.; load resistance, 20,000 ohms; power output (undistorted) 200 milliwatts.

The above characteristics, of course, refer to the triode section of the tube; the diode data may be readily gleaned by reference to the sketches in Fig. 1. It might also be mentioned that with an applied D.C. voltage of 10, the plate current per plate, with an external load should exceed .5-ma.

In concluding, it might be well to state that the available power output of 200 milliwatts is sufficient to drive a pair of 46 tubes to an output of 5 watts.

The ER-49

The use of two tubes operated under class B conditions in the output stage is becoming increasingly popular. While such tubes have been designed to work in A.C. operated receivers, their use is, however, more justified in the case of battery operated sets where the efficiency of conversion of D.C. to A.C. power is of paramount importance rather than in the case of A.C. receivers where the case of power efficiency is of not much importance.

Formally, the '30 type of tubes have been used in a push-push connection in the output of two-volt receivers. For these tubes, it is necessary to use a bias voltage in order to operate under class B conditions. Although the plate current is very low with no signal, the power output of the stage is slightly over 1 watt

with a '30 driver and a suitable step-down output transformer.

The ER-49 is a new type of zero-bias output tube designed for class B operation and offers the following advantage over the older '30 tube when used in the same position. First, because of its zero bias characteristic, circuit arrangements are simplified; second, the power output is approximately three times that of the '30 type tube when both are operating under the same extreme conditions; third, the power sensitivity (a ratio of output power to input voltage) is much higher.

The following rating and characteristics obtain: Filament voltage, 2.0; filament current, .12-ampere. When operated as a class B amplifier, the plate voltage is 180; grid-bias, zero; plate current with no signal, 4 ma. (for two tubes); optimum load resistance per tube, 3,000 ohms; optimum load resistance (plate to plate), 12,000 ohms; power output for two tubes, 3.5 watts; peak plate-current per tube, 50 ma. When operated as a class A amplifier (a single tube), the plate and outer grid voltages are 135; grid-bias (inner-grid), -20; plate current, 5.7 ma.; amplification factor, 4.5; plate resistance, 4,000 ohms; mutual conductance, 1,125 micromhos; power output, 170 milliwatts.

Plate-voltage—plate-current curves of this tube, taken under class B conditions, are indicated in Fig. 3 and a photograph in Fig. B. The outer grid is tied to the control grid in this case; a load line of 3,000 ohms is shown drawn in the figure. This value represents about the optimum value as regards both power output and distortion. It should be borne in mind that this is the load resistance per tube and the actual resistance from plate to plate should be four times this value, or 12,000 ohms. Plate-voltage—plate-current curves, when operated as a class A amplifier with the outer grid tied to the plate are shown in Fig. 4. The tube, under these conditions, has characteristics between a '30- and a '31-type tube.

Consideration of possible drivers show that the '30-type tube would be the only practical tube if "B"-drain economy were considered of primary importance. Results of tests indicate that ideal conditions may be obtained by using a better power tube such as the '31 or ER-49 under class A conditions. An interesting set of curves is that given in Fig. 5 in which

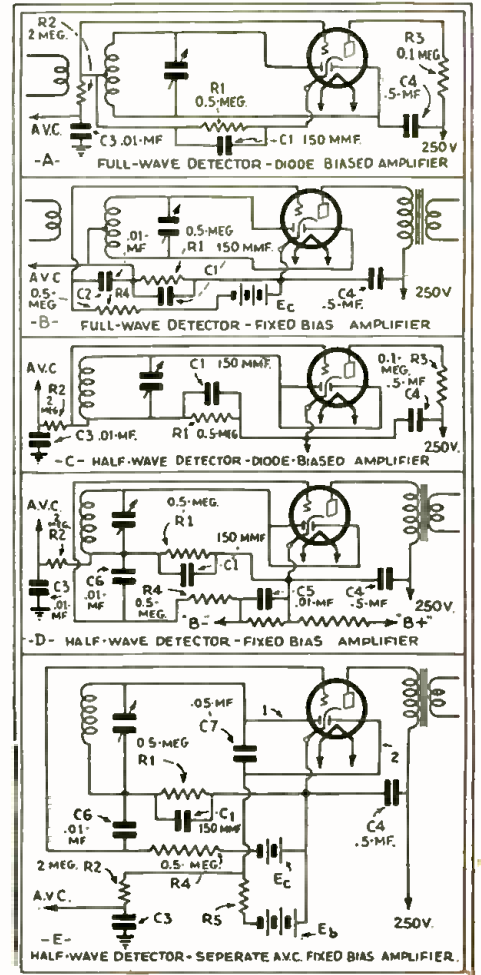

Fig. 1

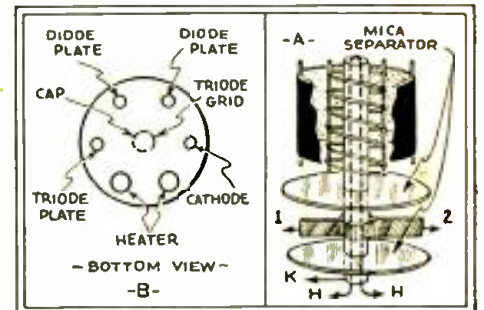

Fig. 2

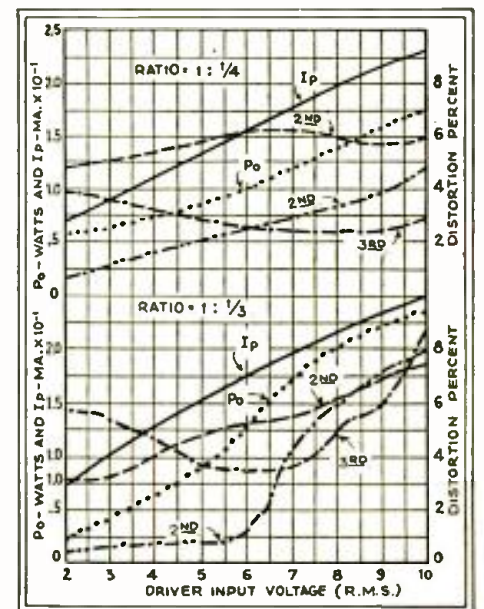

Fig. 5

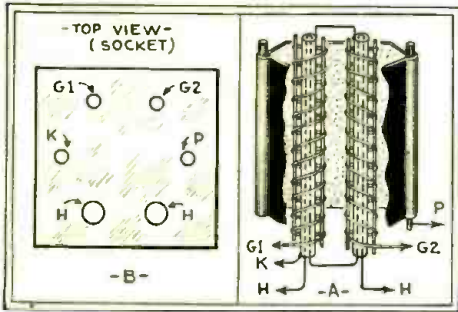

Fig. 6

Right, sketches of the elements; left, socket connections of the 29 and 69 tube.

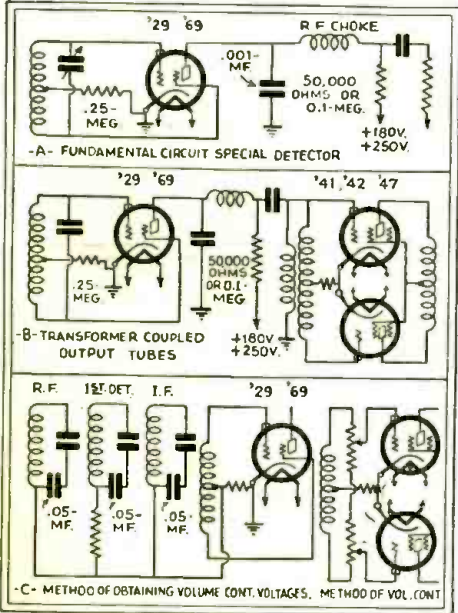

Fig. 7

Circuit connections for the 29 and 69 tube.

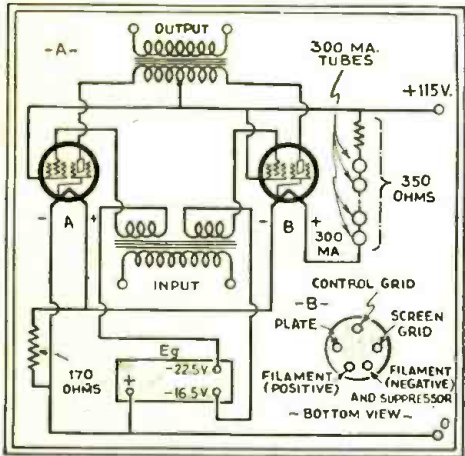

Fig. 8

Suggested arrangement using the TS-257 in a push-pull output stage.

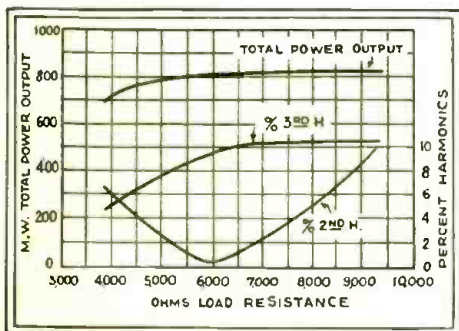

Fig. 9

Curves showing the relation between power output and load resistance of the TS-257.

the results obtained from a 49 output stage fed by a type '32 tube as a driver for two different ratio input transformers. The ratio of the transformers given are from the primary to *half* the secondary. The dashed line shows the effect of shifting the center tap.

The results are very good with an input transformer whose ratio is 1 to $\frac{1}{4}$ but the power developed is only 1.75 watts. The power output for ratio of 1 to $\frac{1}{3}$ is 2.4 watts but the percent harmonics are also somewhat higher for power outputs above 1.7 watts. In all probability, some ratios between 1 to $\frac{1}{4}$ and 1 to $\frac{1}{3}$ will be satisfactory both as regards power output and distortion.

The Type BR Rectifier

The Raytheon type BR tube is a half-wave rectifier of the cold cathode, gas filled type operating on the same general principles as the well-known type BH, and is pictured in Fig. C. This tube has been designed especially for use in "B" eliminators for automobile receivers. The rating and characteristics of this tube are as follows: Peak A.C. voltage, 600; D.C. output current, 50 ma.; internal voltage drop, 60.

This tube is especially recommended for use in the vibrator type of "B" eliminators which characteristically gives a very high peak A.C. wave form. Naturally, the absence of a filament or heater results in increased efficiency of the entire supply unit and increased mechanical ruggedness and reliability in service.

The 85—Double-Diode Triode

For use in receivers where the filament supply is 6.3 volts A.C. or D.C., the 55 type tube discussed at the beginning of this article is termed the 85. This latter tube has characteristics identical to that given for the 55 with the exception of the heater rating, which is 6.3 volts A.C. or D.C. and consumes a current of .3-ampere.

The 43—Output Pentode

Type 43 is a new cathode type power-output pentode equipped with a 25-volt heater. This tube is equipped with a heater requiring .3-ampere, which means that it may be used in series with any of the other .3-ampere tubes. The increased voltage drop across the heater of this tube eliminates the necessity of employing series resistors to reduce the line

voltage. The use of the 43 as an output tube will also reduce the hum and line interference noises usually present in a D.C. line-operated receivers employing filament-type pentodes.

Circuit considerations for this tube are relatively simple. The cathode may be connected directly to the heater or the heater may be biased positive or negative with respect to the cathode by no more than 90 volts. A 6-prong base is employed; looking at the bottom of the base, and going in a clockwise direction, the connections are as follows: Heater, heater, plate, screen, control grid, and cathode. A standard 6-prong socket may be employed. Resistance coupling must not be used with this tube, consequently, only impedance or transformer coupling in standard circuit arrangements are recommended. Two of these tubes may be operated in a push-pull class A connection, in which case no power is required from the driver stage; any tube which will deliver sufficient voltage to the grids may be used between detector and the output stage. The following ratings and characteristics of this tube obtain: Heater voltage, 25 D.C.; heater current, .3-ampere; plate voltage, 95; plate current, 20 ma.; screen voltage, 95; screen current, 6 ma.; grid bias, -15; amplification factor, 90; plate resistance, 45,000 ohms; mutual conductance, 2,000 micromhos; load resistance, 4,500 ohms; maximum undistorted power output, 900 milliwatts.

A type 43 tube used by Philco has characteristics identical with that outlined above with the following exceptions: Screen voltage, 45; mutual conductance, 1,700 micromhos; amplification factor, 60; plate impedance, 35,000 ohms; maximum undistorted output, 700 milliwatts; load resistance 200 ohms. A photograph of the 43 tube is indicated in Fig. D.

Type 69 and 29—Special Detectors

Fig. E illustrates a new Sylvania type 69 and 29 Special Detector combination diode and triode tubes.

Its general theory of operation is very similar to the type 55 discussed in the early part of this article and will not be repeated here. Its construction and circuit arrangement, however, varying from the 55, will be given consideration.

It consists, as may be seen by reference to Fig. 6A, of two separate and distinct cathodes and two grids surrounded by a single plate. The two heaters are connected in series as shown in Fig. 6A. The two grids are brought out to separate terminals on the sockets; the two cathodes are connected together. The socket connections are also shown in Fig. 6B.

Its construction has the distinct advantage of being "fool proof." Fig. 7 depicts several methods of connection. With reference to A of the above figure, the tuned secondary connects to the two grids as indicated. Note that a plate circuit filter is recommended. The input impedance of this tube (the 69 and 29 are identical except for the filament rating)

(Continued on page 171)

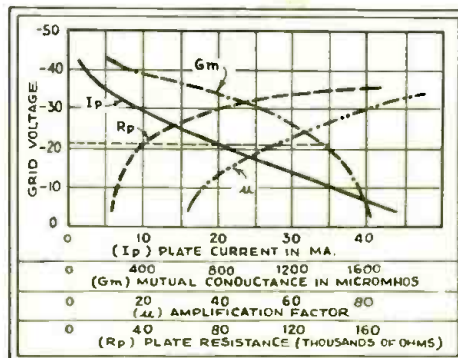

Fig. 10

Dynamic characteristics of the TS-257 tube.

THE LATEST RADIO EQUIPMENT

NEW NATIONAL TUNING DIAL

A LINEAR tuning dial, designed for operation on receivers where full vision and/or clear view is essential, has been produced by the National Company,

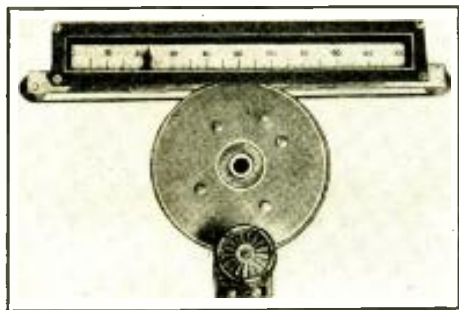

New National tuning dial.

Inc. As may be seen by reference to the photograph above, a knob protruding from the panel operates the linear tuning scale through a drum arrangement. The scale is calibrated, in uniform steps, from 1 to 100 and has black numerals set against a white background.

RECORD CHANGER AND TURNTABLE

HOUSED in a space only 19½ by 9½ inches, the Electromagnetic record changer illustrated in the upper section of the photograph below, plays and changes only 10-inch records automatically and any other records mechanically. It will work on either 33-1/3 or 78 R.P.M. records. Below is shown a turntable with features identical with the device described above with the exception of the automatic record changer.



Automatic turntable and record changer.

NEW CONFIDENCE TESTER

THE Apparatus Design Co., manufacturers of the "Confidence" tube testers announces a new addition to the now well-known line. As shown in the illustration below, the device is similar to the older model but incorporates several new features, as well as testing the more recent tubes.

They are manufactured in two models, a portable and a counter model. The portable unit is designed for the use of the Service Man in the home, while the "counter" model, being 44 inches high, is designed for store use.

Both models are definitely fool-proof and contain no obsolescent features.



New "Confidence" Tester.

ALDEN ADAPTER

A NEW adapter, designed for testing the new 41 and 42 tubes has just been announced by the Alden Manufacturing Co. and is pictured below. It is equipped with a six-hole top with the control-grid contact brought out to a control-grid terminal on the side of the adapter. It has been designed for use in tube testers having a UY socket.

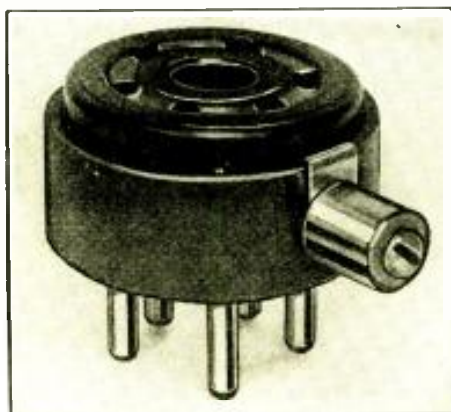

NaAid six-prong adapter.

AN AUDIO AMPLIFIER

THE model 17 combination power amplifier unit, manufactured by the Operadio Mfg. Co. is now available for airport, sound truck, amusement park,



New P.A. amplifier.

and dance hall installations requiring up to 15 watts of undistorted power output. An additional output stage may be supplied delivering up to 30 watts of undistorted output.

The control panel of the amplifier has provision for microphone, radio, and phonograph inputs, including segregated control apparatus.

A LOW CURRENT RELAY

RELAYS may now be secured varying in resistance from .6- to 14,000 ohms and operating directly with .5-ma. through it. This relay, pictured below and produced by the American Automatic Sales Co., is equipped with thumbnuts for adjusting

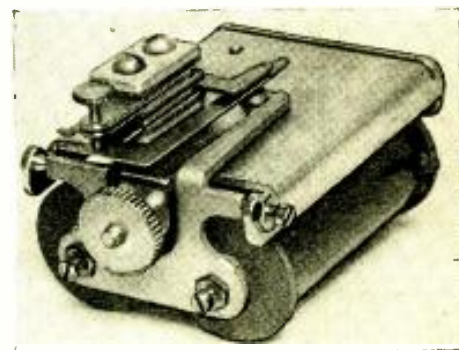

The .5-ma. relay.

the armature gap and for tensioning the moving spring so the operating characteristics of the relay may be readily changed. This thumbnut acts as a micrometer adjustment of the spring tension, facilitating the adjustment so that it will release on the exact current values for which it was designed. The armature is suspended on bronze pivots, which permits practically frictionless operation.

The maximum continuous current for the coils of this relay is based on its ability to dissipate 15 watts.



"Pick 'em out yourself! the prices are all marked." This sidewalk display, at the corner of Cortlandt and Washington Streets, is typical of New York's Radio Row.

RADIO A LA CORTLANDT STREET!

By ROBERT HERTZBERG

"ANY SET—25 cents." This crudely crayoned, yard-square sign, stuck on a heap of once-expensive broadcast receivers, thoroughly exemplifies the spirit of New York's famous "Radio Row," where there are more radio shops per square foot than anywhere on earth. The stores themselves are not big enough to hold all the cut-price merchandise offered to the passing crowds, so they disgorge their surplus onto the narrow sidewalks. Here loud-voiced barkers exhort the cash customers not to overlook the wonderful bargains, and at the same time they keep a sharp lookout for the light fingered gentry to whom the low prices mean nothing.

The whole district has a sort of carnival atmosphere, with only the music, the kooch dancers and the freaks missing. What, you exclaim, no music on Radio Row? Until a few years ago every store kept two or three powerful sets running from morning to night, but the din was so terrific that the city was forced to pass a municipal ordinance to curb it. Where once the roar of the nearby elevated was completely obliterated by the output of 12-inch dynamic speakers, today the receivers in the windows stand altogether silent. Demonstrations are given in private rooms, with soft lights and artificial flowers lending

a much needed air of respectability.

The main axis of Radio Row is Cortlandt Street, on which the majority of the stores are located. The two blocks between Greenwich Street and West Street (which runs along the Hudson River), are practically solid with radio stores, with the exception of a few interlopers, such as beverage dispensaries, and an empty bank. On Greenwich and Washington Streets, which cross Cortlandt, and on Liberty Street, one block south, and Telegram Square, one block north, are dozens of additional stores. Some are mere holes in the wall, perhaps eight feet deep and five feet wide; others are really fine places with balconies and plenty of aisle space.

Why Cortlandt Street?

Just how or why the district assumed its present identity no one knows. A factor of undoubted importance is the location of a string of ferry slips at the foot of Cortlandt Street, from and toward which New Jersey bound commuters stream by the thousand twice a day. During the week the "Street" is filled with normal New York crowds, but on Saturday afternoons it is well nigh impassable, for radio men from the entire metropolitan district come down to do their weekly buying.

A casual tour from store to store soon

reveals the attractions that have crowded Radio Row for ten years. On Washington Street between Telegram Square and Cortlandt Street the visitor finds himself tripping over chasses by the dozen, with the most absurd prices marked on them. Look at the heap pictured below, with the "Any Set 25 cents" sign in plain view. Shades of departed glory! Here we find Radiola second-harmonic super-heterodynes that once sold for \$200; old three-dial Grebe's with their beautiful workmanship; Freshman Masterpieces, with one R.F. coil missing; Stromberg Treasure Chests, once the finest radio instrument in existence—and others too numerous to mention.

Move along a few feet and you encounter a line-up of cabinets, some with sets still in them. Look at that yard-long Fada, marked \$1.00! Or the Philco midget for 50 cents! Of course, everything is sold "as is" and refunds are unknown, but who can go wrong or a mere quarter when one socket or transformer may earn two or five dollars in a repair on a customer's set of the same make?

A sidewalk display at the corner of Washington and Cortlandt Streets draws the visitor because the apparatus looks pretty clean. An Amrad screen-grid job for \$11.50, Atwater Kent Compacts for \$2.50 and \$3.95, Exide batteries that you can't even lift, for \$4.50. This is all workable apparatus, not junk.

And parts! Stuff that you thought went out of existence in '18 finds space alongside of pentode output transformers and make believe the boys aren't buying! You don't even have to go inside a store to do your shopping, as in many places the counters are right on the street, with big items like chasses and loudspeaker baffles hanging invitingly in open sight.

A Radio Paradise

The variety of the parts available is beyond belief, and is amazing to the man who has grown up on mere catalogs. From the Service Man's standpoint the district is a virtual paradise, because in it he can find pretty nearly everything



This is an honest-to-goodness photo of a Washington Street sidewalk. The sign is no joke; you can take away any set you like for one quarter, no more, no less.



Cabinets, with and without sets, 50 cents and up! The center set at the bottom, marked \$1.00, once sold for about \$275. No refunds; you pay your money and take your chances.

There is no city in the world that has a Radio Row comparable to New York's Cortlandt Street. To the great army of Service Men outside of New York City, this article is dedicated. Read it and weep!



Why go into a store. Just gather your parts on the run. Look at these prices for aluminum chassis! 25 cents, 75 cents, 85 cents, and all cut, drilled and bent.

that was ever made in radio, from the year one and on. This is by no means an exaggeration. One famous store, hardly wide enough to accommodate two people but running three stories high, will sell you pre-war loose couplers and *electrolytic detectors* in their original factory cartons also fixed spark gaps, coherers, oscillation transformers, and absolutely any ancient part you can think of. Only a few steps off the busy waterfront, it is a meeting place for radio operators from all over the world.

They come in to buy spare or replacement parts for their private short-wave receivers, for their captains' broadcast sets, and for the sets of friends and relatives in remote places where an extra tube or filter condenser may save months of boredom or loneliness. They often leave souvenirs in the form of tropical fish, South Sea Island shells, Japanese fans, etc., which help to dress up the window displays.

Don't get the idea from the foregoing that only obsolete junk is on sale along Cortlandt Street. Far from it. The street boasts a number of flouncy stores, with canopies 'n' everything, where you can see, hear and buy the very latest superhets with two or more loudspeakers, and where you can be waited on by polite salesmen who actually wear coats and speak English.

Auto Radio Booming

The Street attracts the ordinary radio buyer as well as the professional worker, for here a prospective purchaser can look over everything the market has to offer without walking more than two blocks from the subway and "L" stations at the corner of Cortlandt and Greenwich Streets. Some of the stores with small fronts have considerable display space inside, where a bewildering array of receivers ranging from tiny midgets to big phonograph combinations awaits the customer. One firm has just taken over an old movie theatre, and by removing the seats, covering the screen with big posters, and building up wall and floor dis-

plays, has created a permanent little radio show all its own. The former balcony serves as a convenient and accessible stockroom.

The latest development along Radio Row is automobile radio. It is an inspiring sight to the visiting Service Man to see the curbs parked solid with all kinds of automobiles, on, in, and under which one or two men are working. A car owner can leave his machine in front of a store in the morning and drive it away in the afternoon with a complete radio receiver in it. The installation men run A.C. lines out from the stores to the curb, draping them around convenient light poles to prevent passersbys from tripping over them. Oblivious of the curious crowds that gather to watch them work, they dope up ignition wiring, saw out footboards, rip out upholstery for aeriels, and snake wires around hot exhaust pipes and steering columns. A lunch hour tour on an average Tuesday revealed more than two dozen cars being fitted with auto radio, right on Telegram Square and Washington and Cortlandt Streets. There must have been as many cars on the side streets.

Taking advantage of the gathering crowds, the store owners put big signs on the tops of the cars, giving prices and descriptions of the auto sets they sell.

Circulars are handed out freely, and business appears to be booming.

Special Service Station

So far the police have been obligingly tolerant of the curbside activities, but traffic being what it is in lower New York, some of the store owners are making other provisions for their rapidly expanding auto-radio business. One man, now occupying a large store, has rented an adjoining one, which he plans to equip as a special auto-radio service station. The car owner, instead of leaving his machine at the curb to the not-so-tender mercies of the curious onlookers, will drive it right into the store, where it will be fitted with a receiver in jig time. This arrangement is the answer to the question that has perplexed auto-radio manufacturers for so long: should auto sets be installed by auto mechanics who have only a faint notion of what it is all about, or by competent radio Service Men who know just what they are doing?

It is an unusual auto mechanic who knows how the third brush on a charging generator works; and he is even more unusual if he can distinguish between the primary and secondary of an audio transformer. A radio Service Man, familiar with the intricacies of superheterodyne power systems, finds an auto ignition system child's play.



Radio Row's latest boom—auto radio. Service Men are enjoying considerable business in this field. A little thing like a fire hydrant doesn't annoy these men at all.



A common scene on Cortlandt Street: watching an auto radio receiver being installed. Note the sign on the top of the car. Plenty of interest, and plenty of business.

HOW TO BUILD A HIGH-GAIN T. R. F. RECEIVER

*230GR
3EQD
GD*

*230GR 8 1/2
EQD 1 1/2
20*

By S. H. BURNS

120-#28 Enamel

Complete constructional details of a T.R.F. receiver of high gain and unusual selectivity. This receiver may be operated close to a powerful station without any interference.

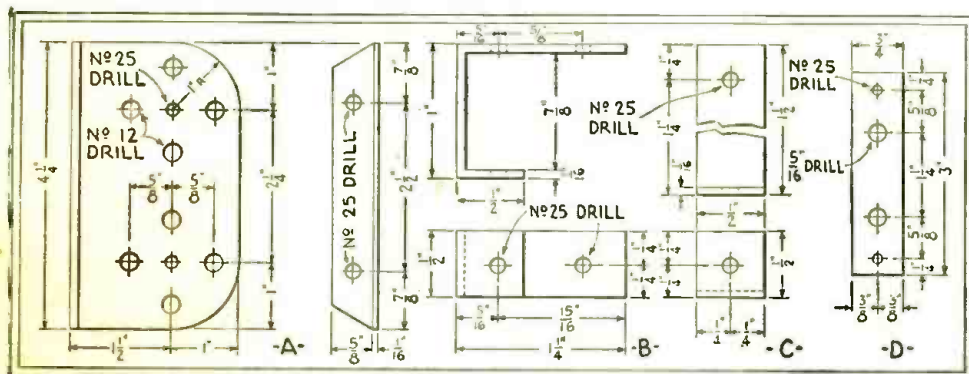

Fig. 3

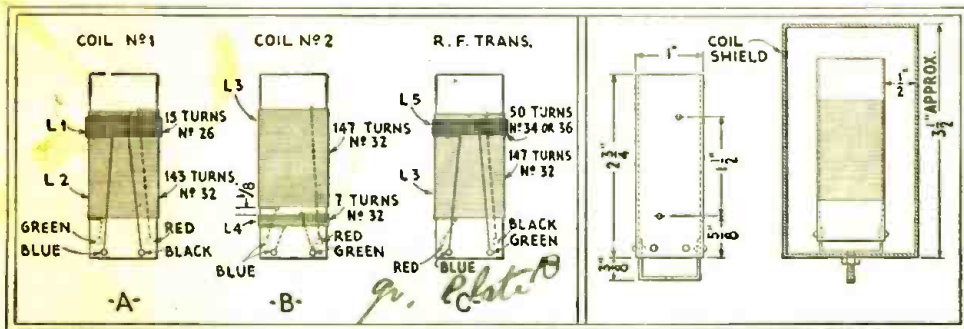

Fig. 4

Fig. 5

Fig. 6

The input to the first of these tubes consists of a doubly tuned bandpass circuit. This will justify itself when the receiver is operated close to one or more powerful broadcasting stations. An R.F. transformer couples the last '35 to a '27 power detector. In all there are five tuned circuits giving more than enough selectivity to the set. The sensitivity is taken care of by the three high- μ tubes. Following the detector, resistance coupling is used into a '27 audio stage; this, in turn, supplying signal voltage to two '45 power tubes through an input push-pull transformer. The high output of the detector is amply augmented by the first-audio tube to supply the necessary power to these two output tubes. For this reason, it was not found advisable to use the higher gain '47 tube as the signal grid voltage would certainly be too high. The power supply section of the receiver is conventional with the exception of the manner of securing the '45 plate supply ahead of the last choke. This does away with one of the heavy chokes.

Controlling Oscillation

Oscillation is the great bugbear encountered in using high- μ tubes. Of course the circuit can be prevented from breaking into oscillation by increasing the bias on the variable- μ tubes; but to secure the great sensitivity that these tubes are capable of, they must be used in a circuit that prevents their oscillating with the bias set for greatest gain. This accomplished, the set will give the utmost

THE average builder of radio sets looks upon high- μ tubes as a bit too complicated to be understood by anyone but a highly trained radio technician. In this article I have attempted to show that a highly efficient high- μ receiver can be built by the lay-

man; and that if he will use care and patience in following the instructions given, he will achieve results that will surprise him.

Referring to the set diagram, Fig. 1, it will be seen that the R.F. end of the set employs three of the '35 variable- μ tubes.

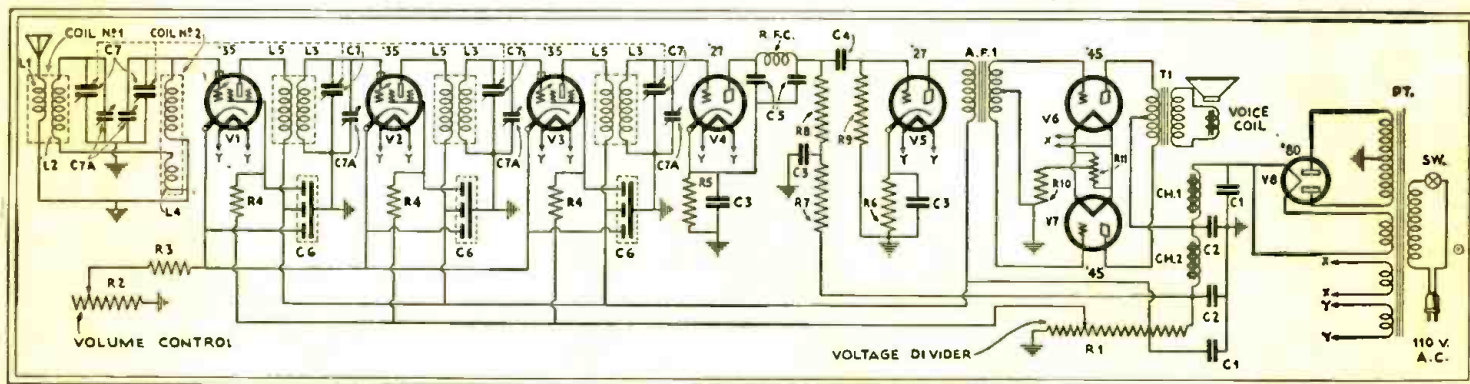

Fig. 1

Complete schematic circuit of the receiver. This set, as may be seen, has no "strings" attached to it—it may be easily constructed at home.

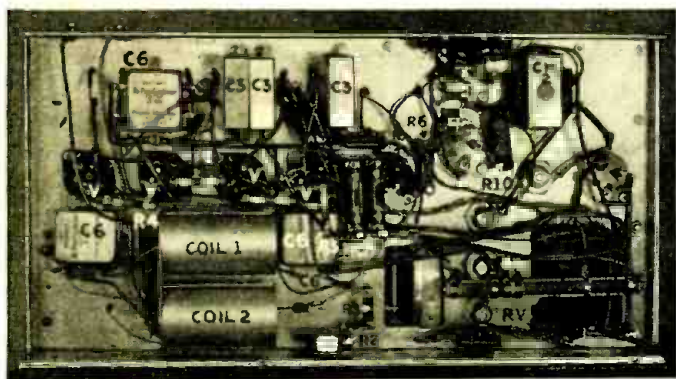

Fig. B
Under-chassis view of the receiver.

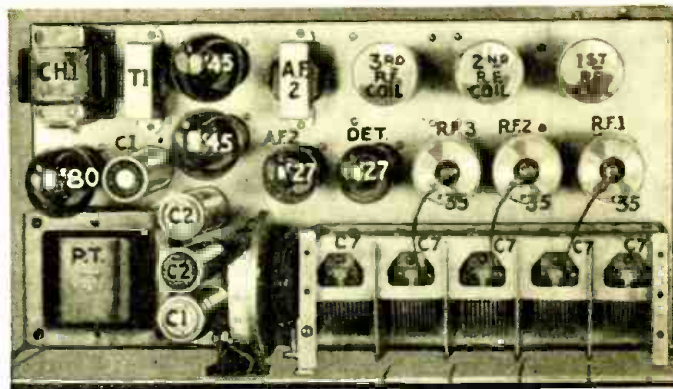

Fig. C
Top-of-chassis view showing the location of parts.

gain and the grid-bias control will be used for controlling the volume and not the oscillation. To gain this end, the circuits must be shielded properly, so that all coupling will be eliminated between the R.F. stages. Further, the tubes must be supplied with the proper voltages on the screens and the plates. But before beginning the actual construction, the matter of shielding must be attended to.

Making a Suitable Chassis

The complete receiver should be built on an aluminum chassis, and bypass condensers, resistors and wiring kept underneath—out of sight. As the photographs,

Figs. A, B and C show, only three short connections to the grid caps on the tubes are visible from the top. With the parts listed, the set can be laid out according to the drawings with the assurance that each part will fit into place.

A sheet of medium grade 3/32-in. aluminum, 15⁷/₈ inches wide by 21¹/₂ inches long is used for the chassis. See Fig. 2. The cutouts at each of the four corners are alike, and after marking, should be removed with a hacksaw. The two rectangular cutouts will not present any difficulty, if a half-inch hole is first made in each corner. Now, using one half of a broken hacksaw blade, cover one end



Fig. A
Panel view of the T.R.F. receiver.

with tape for a grip, and saw along the lines between the holes. Square up the corners and finish to the line with a file.

Eight holes, 1¹/₂ inches in diameter are used for the sub mounting sockets. An
(Continued on page 173)

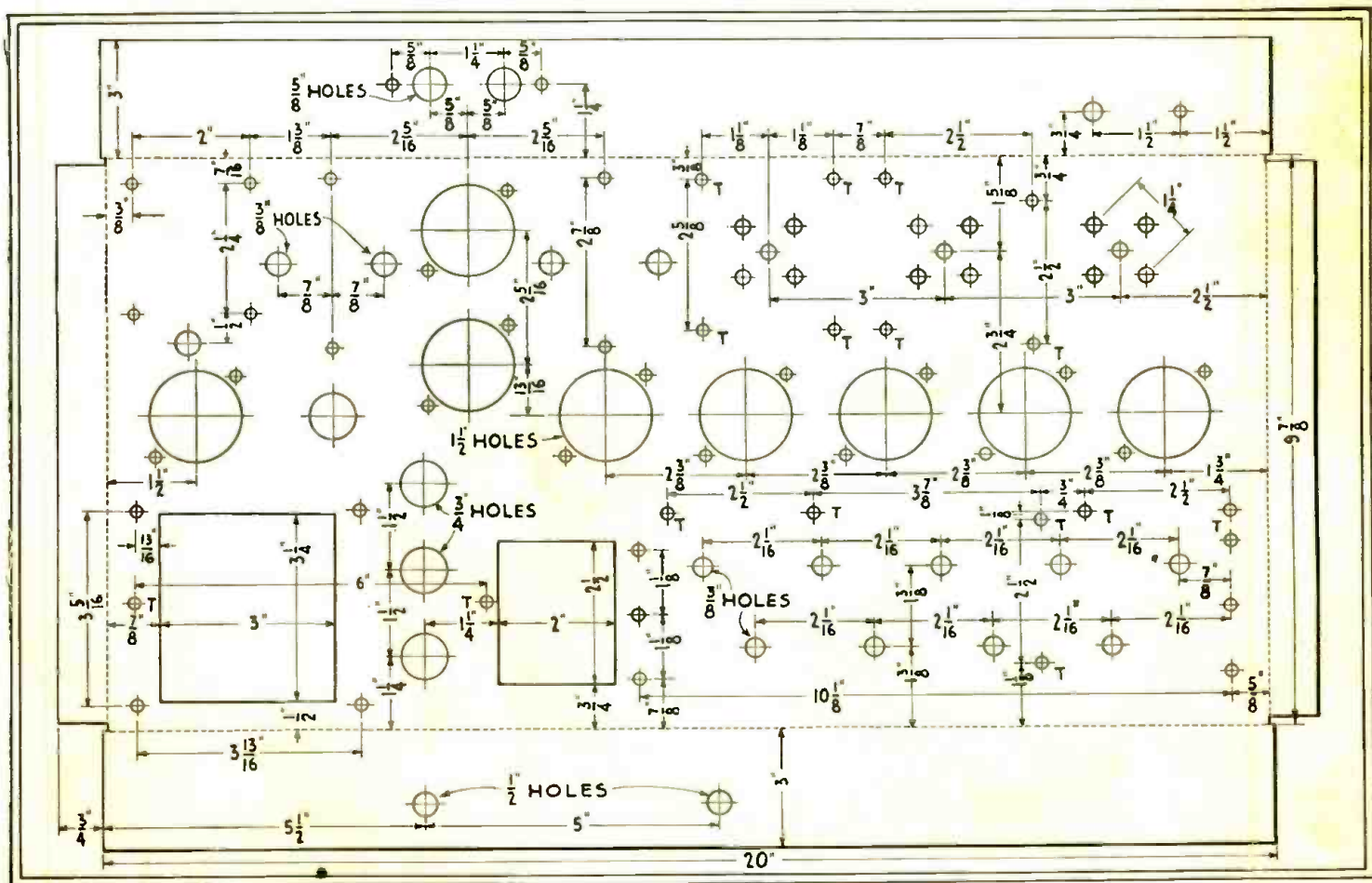
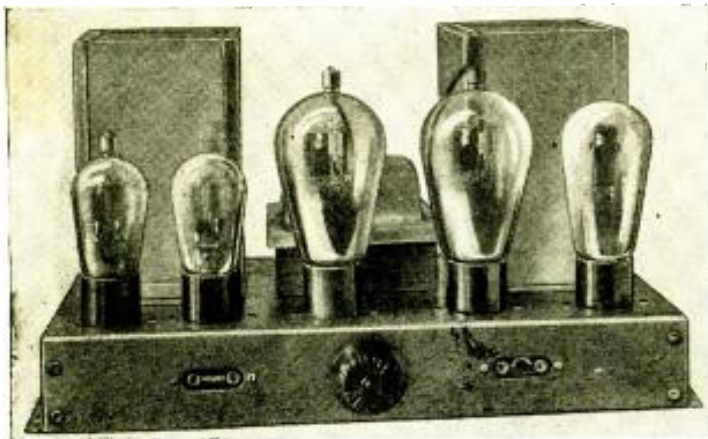
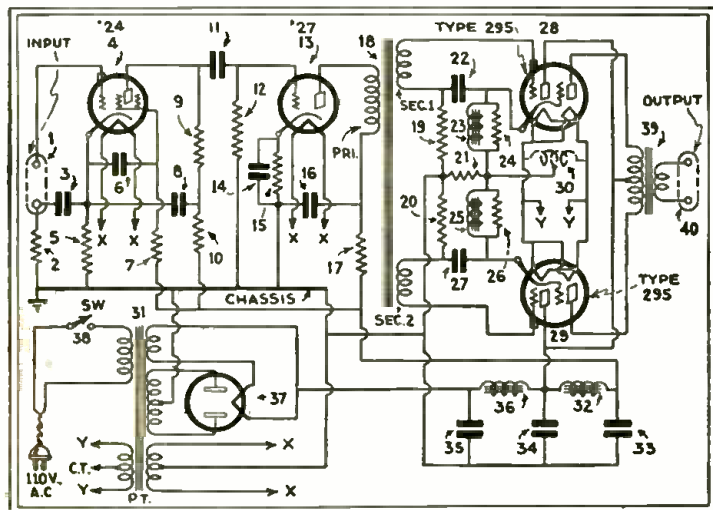

Fig. 2
Complete chassis layout of the selective T.R.F. receiver designed by Mr. Burns.



Photograph showing the new twin, triple-twin P.A. amplifier.



Schematic circuit of the new amplifier.

A TRIPLE-TWIN P. A. AMPLIFIER

By HARRY GEORGES

It generally takes considerable time and experimentation before the ultimate possibilities of a new tube can be realized—and the triple-twin tube is no exception to this rule. At this moment, the latest development in the application of the triple-twin is a three-stage amplifier, using triple-twin tubes in push-pull in the output stage. This design was originated and data for this article was furnished by Mr. Sidney Fishberg, chief engineer of the Baltimore Radio Corp..

This amplifier has an overall gain of 85 db. at 1,000 cycles, with less than 10 percent drop at 50 cycles and about 20 percent drop at 10,000 cycles. It has a maximum undistorted output of 15.5 watts. The new amplifier can be used directly from a photoelectric cell and, of course, it may be used directly with phonograph pick-up, microphone or radio detector because of its "universal" input. A resistor of about 500 ohms is required across the input terminals when using a microphone, so as to furnish a closed circuit for the microphone current.

The use of a heavy duty output transformer is absolutely essential, and since the output impedance necessary with 295 tubes in push-pull is 8,000 ohms, a '50-type push-pull output transformer will serve the purpose. It is not necessary for the

primary of this transformer to be split; a center-tapped winding will serve the purpose. No special provision is necessary to eliminate hum, since the push-pull action automatically cancels this out.

The Values of Parts

The values of the various components are as follows: In the first two stages, resistors (2), (5), (7), (9), (10), (12), (15), and (17) are 100,000 ohms, 2,000 ohms, 500,000 ohms, 300,000 ohms, 25,000 ohms, 500,000 ohms, 2,700 ohms, and 15,000 ohms respectively. Fixed condensers (3), (6), (8), (11), (14), and (16) have the respective values of 2 mf., 1 mf., 1 mf., .05-mf., 25 mf., and 2 mf.

In the push-pull stage, resistors (19) and (20) are 100,000 ohms ($\frac{1}{2}$ watt) each; resistors (24) and (26) are 12,500 ohms (1 watt) each; while (21), which is the only resistor common in the push-pull circuit, has a value of 135 ohms (5 watts).

The bypass audio chokes (23) and (25) have an inductance of 15 henries each and a D.C. resistance of 200 ohms. Low resistance chokes are necessary so as to keep the voltage drop low in order not to increase the bias potential of the first sections of the 295 tubes.

A large power-supply transformer, having good regulation, must be used. This should have a 700-volt center-tapped winding (350 volts each side), with one 8 ampere, 2 $\frac{1}{2}$ -volt winding for the 295 filaments and one 1-ampere, 2 $\frac{1}{2}$ -volt winding for the '24 and '27 filaments. Naturally, a winding must be provided for the '80 rectifier tube. It will be noted from the schematic diagram that the plate voltage for the two triple-twin tubes is taken from a connection between the two audio chokes (36) and (32), whereas plate voltages for the '24 and '27 tubes are taken from a connection on the far side of the two chokes.

In addition to the unusually high gain possessed by the triple-stage, push-pull triple-twin amplifier, it is also noteworthy because of its remarkable compactness, its light-weight, portability, low hum voltage, and its ability to perform, with uniform amplification throughout the entire range of audibility, with marvelous brilliance of tone. The completed amplifier is shown in an accompanying illustration. The overall dimensions are length 14 $\frac{1}{2}$ inches, width 8 $\frac{3}{4}$ inches, and height 8 $\frac{1}{2}$ inches. The tubes from left to right are '24, '27, 295, 295 and '80. The power transformer is of the flush-mounting type and may be noted in back of the 295 tubes. Input and output twin jacks are mounted on the front chassis wall.

Three I.R.C., 100,000 ohm, $\frac{1}{2}$ watt, metallized resistors, (2), (19), (20);

One Electrad, 2,000 ohm, 1 watt flexible resistor, (5);

One I.R.C., 500 ohm, 1 watt, metallized resistor, (7);

One I.R.C., 500,000 ohm, $\frac{1}{2}$ watt, metallized resistor, (12);

One I.R.C., 300,000 ohm, 2 watt, metallized resistor, (9);

One I.R.C., 25,000 ohm, 1 watt, metallized resistor, (10);

One Electrad, 2,700 ohm flexible resistor, (15);

One I.R.C., 15,000 ohm, 2 watt, metallized resistor, (17);

One Electrad, 135 ohm Truvolt, 5 watt resistor, (21);

Two I.R.C., 12,500 ohm, 1 watt, metallized resistors, (24), (26);

Three Aerovox, type 261, 200 volt, 1. mf. condenser, (3), (6), (8);

One Aerovox, type 260, .05-mf. condenser, (11);

One Aerovox, type E 25-25, 25-volt, dry electrolytic condenser, 25 mf., (14);

One Aerovox, type 407, 400 volt, 2 mf. condenser, (16);

Two Aerovox, type 207, 200 volt, 2 mf. condensers, (22), (27);

Three Aerovox, type P 5-8, 8 mf. electrolytic filter condensers, (33), (34), (35);

One Baltimore, split secondary (4 or 5 to 1) audio transformer, (18);

Two Baltimore, 200 ohm, 15 henry choke, (23), (25);

One Baltimore, 20 henry, 20 ma. audio choke, (32);

One Baltimore, 30 henry, 100 ma. audio choke, (36);

One Webster, type 250, push-pull output transformer, (39);

One Baltimore Power transformer, 700-volt, center-tapped, two 2 $\frac{1}{2}$ -volt and one 5-volt windings, (31);

Four Twin-jack terminals, (1), (40);

One Type '24 Screen-grid tube, (4);

One Type '27 tube, (13);

Two Speed, type 295 tubes, (28), (29);

One Type '80 Rectifier tube, (37);

One "On-off" Power Switch, (38).

HOW TO CONSTRUCT 46, CLASS B APPARATUS

By C. H. W. NASON

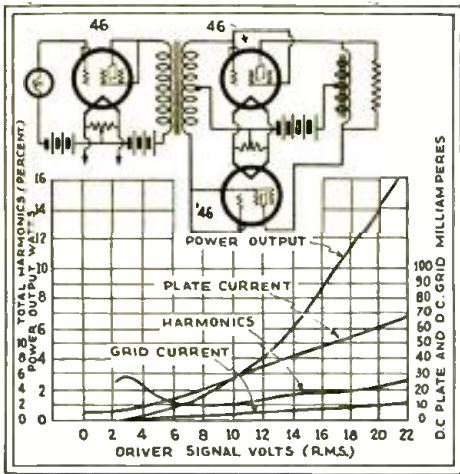

Fig. 1
Characteristics of the 46, class B tube.

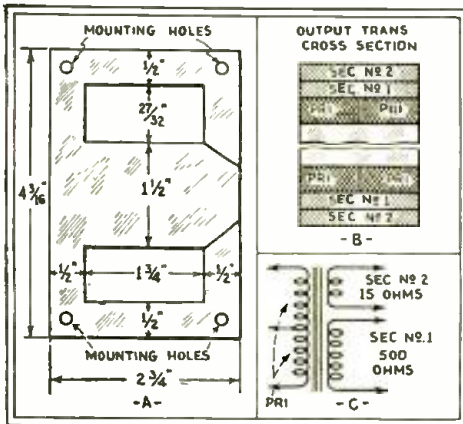

Fig. 2
Construction details of an output transformer suitable for class B work.

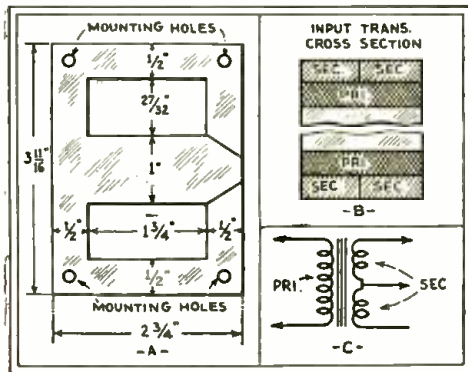

Fig. 3
Details for making the push-push input transformer.

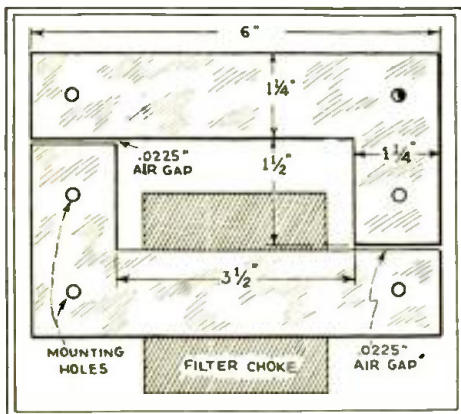

Fig. 5
Note the use of the air-gap in this choke.

A CERTAIN amount of distortion is admittedly inherent in the class B system due to the non-linearity of the system at low volume levels. The system also offers difficulties through the fact that grid current of considerable magnitude is drawn throughout the operation of the tube. The 46 has the advantage over the '10 when operated in class B circuits in that the grid current is drawn through practically all of the signal cycle. Distortion may, therefore, be grouped into two classifications—high level and low level. With a proper output circuit the distortion due to non linearity at the highest levels is minimized to that accounted for in the flow of grid current.

46 Operation

The 46 contains two grids—the method of connection of the grid nearest the plate determining its manner of operation. If the two grids are tied together, the tube draws little or no plate current at zero bias and is thus operated as a class B amplifier. With the grid nearest the plate tied to the plate, the tube becomes a low-mu tube similar in properties to the '45 and may be operated as a class A amplifier in the output circuit of a receiver—singly or in push-pull—or

it may be used to drive a pair of 46 tubes in the class B connection. A considerable power is required of this driver tube since it is called upon to supply the power losses resulting from the flow of grid current. Operated as a simple class A amplifier, the 46 seems to be an excellent tube in its own right. The characteristics are as follows:

Filament potential, 2.5 volts; plate potential, 250 volts (max.) grid bias, —33 volts; amplification factor, 5.6; plate resistance, 2,380 ohms; mutual conductance, 2,350 micromhos; plate current, 22 ma.; load, 6,400 ohms, twice this value when used in a class B connection. Maximum undistorted power output, 1.25 watts.

In the class B connection, the grid is returned directly to ground and the tube is operated at a plate voltage of from 300 to 400 volts. Fig. 1, taken from R.C.A. data, shows the class A driver and the class B circuit taken as an entity and indicates the harmonic distortion as well as the power output for various input voltages from zero to 22 volts. It may be seen that if the three tubes are treated as an entity—and indeed they must be so treated in design—the power sensitivity is not so low as might be imagined. The power sensitivity, according to the Ballantine interpretation, is, of course, below that of either the '45 or '47 as normally employed. But, when we consider the fact that the system may readily be driven to full output by an average power detector—and that that detector must operate at a high level if distortion is to be avoided, there seems to be no valid reason for discriminating against the system on those grounds.

The Output Transformer

The output transformer feeding the loudspeaker from the class B, 46 stage presents no great problem in design and is no more expensive than the transformers necessary for push-pull operation with '50s. In Fig. 1, the designation of the total load from plate to plate as 3,500 ohms, means that each tube has a load of one-quarter of this value or about 875 ohms. This gives the maximum allowable grid swing with the minimum grid current and consequent freedom from distortion.

The output transformer may easily be constructed at home if the specifications given here are adhered to. Refer to Fig. (Continued on page 175)

Fig. 4
Core size and winding data for the power transformer.

AN AUTOMOTIVE "B" ELIMINATOR

The rapid growth of automobile radio demands an auto-radio "B" eliminator such as described here.

By DR. JOSEPH H. KRAUS

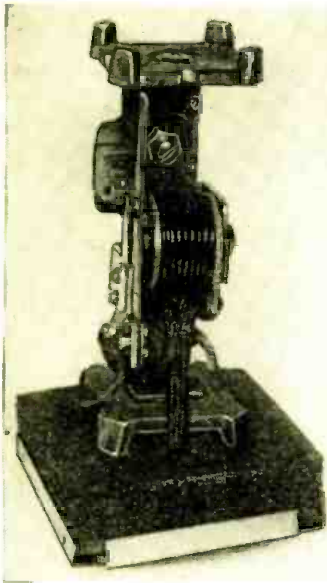

Fig. C
The interrupter or elkonode.

THAT those "in the know" knew whereof they spoke, when they forecast that automotive radio would soon reach the proportions of a small industry, is daily becoming more evident. The process is regenerative, since new merchandise particularly designed for car-radio use and offered by one manufacturer is rapidly absorbed by the public and is immediately followed by the advent of improved units designed by other manufacturers who have been spurred on by the success of the first.

One of the first questions the car owner asks is, "How will the current requirements of this set affect the storage battery in my car?"

Before the advent of "automotive" tubes the answer was none too satisfactory; now, the car battery need supply only the filament current, unless an economical design for the "B" circuit is available. The convenience which the latter arrangement affords is an important factor in its favor.

In Fig. A is illustrated the most modern

"B" unit designed to operate at high efficiency in transforming the 6- or 12-volt potential of the storage battery up to 180 volts or less; the schematic circuit is Fig. 1.

The components shown in Fig. A are described as follows: A, shock-absorbing spring on the base-plate; B, tuned filter; C, elkonode; D, storage battery connection strip; E, gaseous, half-wave, type BR rectifier; F, high-voltage transformer.

In Fig. B is shown the complete Type 6 equipment required to obtain "B" potentials and current in accordance with Table I, below.

TABLE I

Type Unit	Watts Output	Amps. Input	180 V. at Ma.	135 V. at Ma.
6	6.3	2.45	35	46
5 & 5P	5.4	2.1	30	40
4 & 4P	4.5	1.8	25	33
3 & 3P	3.6	1.5	20	27
2	2.7	1.2	15	20
1	2.2	1.1	12	16

Any of these types may be converted

into another by interchanging the "elkonodes," or interrupters. For example, a Type 6 eliminator may be converted into a Type 3 by removing the Type 6 elkonode interrupter and inserting a Type 3. The resulting Type 3 eliminator may be converted into a Type 3P merely by changing the resistors connected in back of the distribution panel shown, in Fig. A, above units B and E; the same procedure is followed in connection with the conversion of a Type 5 eliminator to Type 5P. Eliminators Types 2, 3, 4, 5, and 6 are equipped with resistors of 20,000 and 75,000 ohms for units R1 and R2, respectively, in Fig. 1; for Type P eliminators the values are 40,000 and 50,000 ohms.

In Fig. B, at the extreme right, appears an automatic relay which does not connect the "B" eliminator until the "A" circuit of the associated radio set is completed by operation of the "off-on" switch.

Illustrated in Fig. C is the elkonode interrupter—the heart of these eliminators. The general idea of such units has been discussed in the article, "The 'B' Tube,"

(Continued on page 176)

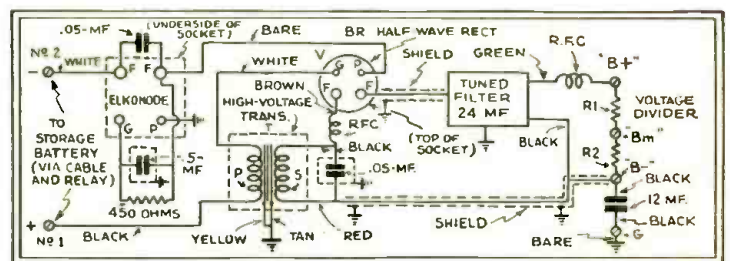
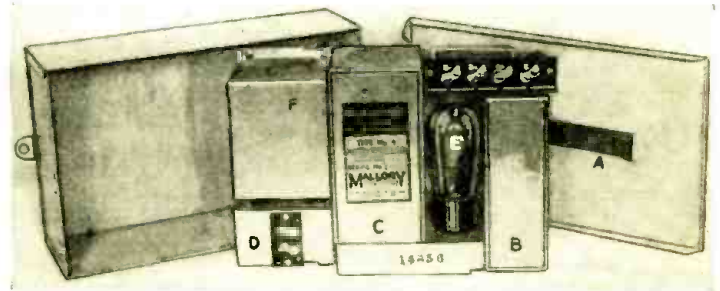
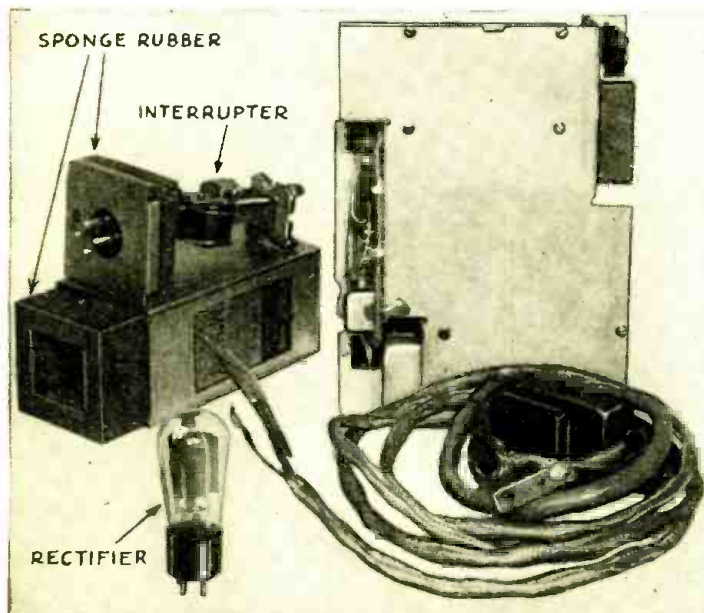

Fig. A, upper. Photograph of the Mallory "B" unit.
Fig. B, left. The component parts are shown here.
Fig. 1, above. Schematic circuit of the Mallory unit.

IMPROVEMENTS IN ELECTROLYTIC CONDENSERS

By DONALD E. GRAY*



Photograph comparing the sizes of electrolytic and paper condensers, each having the same capacity—about 8 mf.

THREE desirable characteristics of electrolytic capacitors are listed in the order of their importance, as follows:

1. Quick reforming or comeback time, which indicates low leakage, thereby conserving the solution; low losses with a minimum amount of internal heating, thus prolonging the life of the capacitor;
2. High breakdown voltage to take care of surges and variation in voltage;
3. Low power factor.

Recent requirements for condensers occupying small space and having comparatively high capacity, have stimulated the development of the electrolytic type of capacitor to the extent where it now seems probable that many of the commercial condensers formerly using paper dielectric will now be replaced by these new types.

This dielectric is a metallic oxide which entirely covers the positive plate. It is not visible to the unaided eye, and is many times too thin to be measured by ordinary means, being about .000,000,26 inches in thickness. It can be made visible, however, if the metal is removed from the dielectric by dissolving it—in the case of aluminum, in a caustic soda or caustic potash solution. Since the dielec-

tric is extremely thin, the capacity per unit area will be very great; thus accounting for the comparatively small size of electrolytic capacitors.

There are three types of electrolytic condensers namely, the wet, with a solution of very low viscosity, almost like water; the semi-dry, wherein the solution has about the same consistency, as syrup; and the dry type, the solution of which almost resembles a putty in structure. The working principles of these three types are about the same, all having a positive aluminum plate coated with the dielectric oxide, and the oxidizing solution, such as boric acid, as the negative. *However, the type of metallic oxide used for the dielectric greatly differs, and the desired characteristics of a good condenser will usually be affected by the type of oxide coating.*

The disadvantage of the wet type lies in the fact that if any of the solution is lost by evaporation or leakage, the capacity of the condenser decreases. The capacitor can usually be mounted only in one direction; and it is generally objectionable to have any freely flowing liquid in a small, mechanically-weak container. The dry and semi-dry types can be mounted in any position, and usually have a much higher breakdown voltage.

It must be taken into consideration that when this type of capacitor is connected in the circuit, some chemical action will take place. There is a sudden inrush of a large "leakage current," in some sam-

ples tested by the laboratory, of several hundred milliamperes! This leakage current tends to immediately form additional oxide coatings, and thus increases the resistance and rapidly reduces the leakage current. If this leakage current persists for any length of time, and does not decrease rapidly to a small fraction of a milliampere, heat will be generated within the condenser, due to the I^2R losses. The chemicals will be used up, and the capacitor will tend to deteriorate with time. Besides, a fair amount of gas might be generated which might injure the capacitor. This period of decrease in the inrush of current to normal condition is called the "comeback time," and in our product we have found it is usually a few seconds, and the leakage current becomes a fraction of a milliampere, so that the heat and gas generated are negligible.

The curve Fig. 1, shows the comeback time at 500 volts during different time periods, also the changes in capacity and power factor with and without current during life tests.

Other characteristics, such as power factor and breakdown voltage, are to be seriously considered. By simple calculations it can be easily seen that if power factor is kept below 10 or 15 percent, it is satisfactory; although the capacitor could be constructed to obtain much lower power factors, this is accomplished only at the expense of other desirable characteristics, such as breakdown voltage, comeback time, and low-leakage currents.

Whenever there is a breakdown, it not only tends to lower the life of the capacitor, but increases its undesirable characteristics; therefore it is found that the breakdown voltage can be considerably increased by a slight increase of power factor, and this desirable feature more than outweighs the slight increase in power factor.

In the manufacture of the capacitors, the positive electrode is cut to the desired area to obtain the correct capacity, wound into a roll with the foil and separated with a layer of an absorbent cotton gauze, the gauze having been previously saturated with the desired salt or acid solution, and through the proper connections, the current is passed from one electrode to the other. This process is called *forming*, and places the metallic oxide coating on the positive foil.

(Continued on page 176)

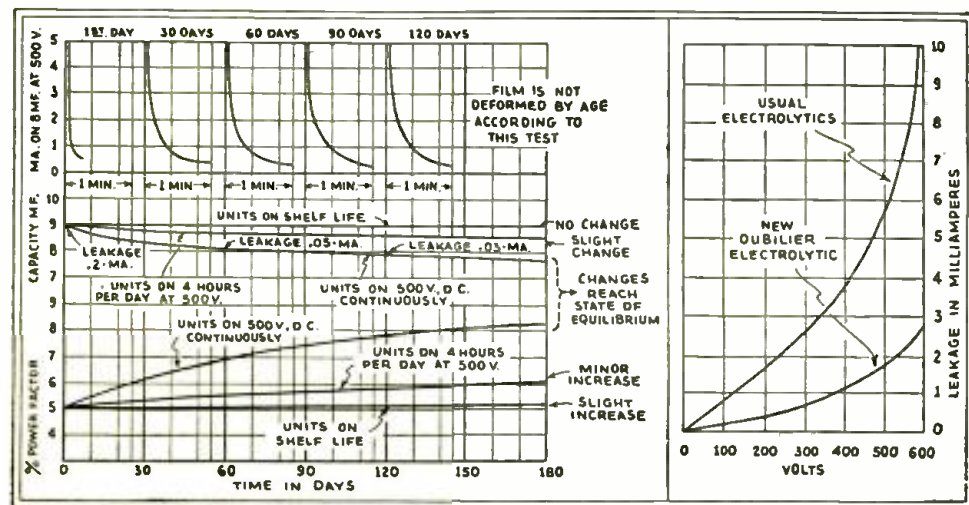

Fig. 1

The curves at the left illustrate a phenomenon of electrolytic condensers while the curves at the right, the old and new leakage currents.

OPERATION AND SERVICE OF AUTOMATIC VOLUME CONTROL SYSTEMS

By W. S. WILLIAMS

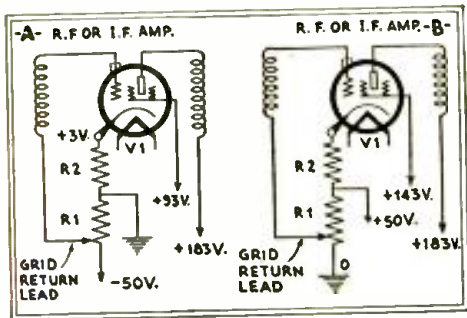

Fig. 1
A volume-control circuit for variable-mu tubes.

RADIO has made rapid strides in the last few years. Service Men and experimenters have found themselves hard put to keep up with the newest developments. Of these new developments, perhaps none has been more puzzling than automatic volume control—"A.V.C." While everyone admires the manner in which a receiver using automatic volume control operates, very few seem to know how it works or what to do to it when it doesn't work. It is hoped that this article will clear up some of the mystery that surrounds this subject. There will be little consideration of the subject in connection with the earlier types of tubes, as this phase has been very well covered in the article, "Automatic Volume-Control Systems," by C. H. W. Nason, in the November, 1930 issue of RADIO-CRAFT.

There are two systems of A.V.C. in general use. One uses a separate tube which functions as a regulator to keep the volume constant, and has no other duty to perform; this A.V.C. method permits the use of a power detector, the output of which may be fed directly into the output power stage. The other incorporates the A.V.C. action and one or two other functions in a single tube. Since the former system is more popular, (See pg. 667, Fig. 1, in the May, 1932 issue; compare this with Mr. Nason's Fig. 3.), it will be considered first.

Most modern radio receivers incorporating A.V.C. make use of the variable-mu tube, designated as type '35 or '51, so let us take up the conditions under which these tubes should be operated. To realize the full possibilities of these tubes, the negative bias applied to the control-grid should be variable from a minimum of 3 volts to a maximum of about 50 volts. The plate and screen-grid voltages, as measured from the cathode, should remain constant—or nearly so. This requirement definitely eliminates a variable resistor in the cathode circuit—the system generally used with the types '27 and '24 tubes.

Simple A.V.C. Circuit

The suggested volume-control circuit for use with variable-mu tubes is shown in Fig. 1A. It will be noted that in the cathode circuit there is a fixed resistor, R2, of such value that when the rated voltages are applied to the plate and screen-grid, the voltage across R2 is 3

volts; thus, this potential is established as the minimum bias of the control-grid. Of course, when the bias is increased by manipulation of the volume control, R1, the voltage across R2 will be reduced, due to lowered plate current, producing a corresponding change in the plate and screen-grid voltages; but since the variation cannot exceed 3 volts minimum, the operation of the tube is not affected to any perceptible degree and no corrective measures are necessary. (These voltages could be made invariable by applying a positive potential of 3 volts secured from the voltage divider, but this presents other complications and the simpler method illustrated is the one that is generally used.) Since at this time we are dealing with direct current only, all bypass condensers have been omitted for the sake of simplicity.

As an examination of the diagram will show, the grid-return lead is brought to the movable arm of a potentiometer R1 connected between the ground or chassis, and a point in the voltage divider system that is 50 volts negative with respect to the chassis. In this instance the potential of the chassis is assumed to be zero.

Now, in case the lowest potential existing in the voltage divider system is common with the chassis, the diagram shown in Fig. 1B is used. Here the cathode resistor R2 instead of being connected to the chassis, is connected to a point in the voltage divider system that is 50 volts positive with respect to the chassis. The plate and screen-grid potentials are likewise increased to maintain the rated voltages between them and the cathode. Now it will be seen that by adjusting the volume-control potentiometer R1 the bias can be varied from a minimum of 3 volts—secured by the resistor R2 in the cathode circuit—to a maximum of 53 volts—the total voltage across R1 and R2.

Now let us examine Fig. 2A. Here we find that the potentiometer has been replaced by two resistors, one variable, R1A and the other fixed R1B. The fixed unit is connected between the grid return and the cathode, while the variable resistor is between the grid return and a point in the voltage divider system that is 50 volts negative with respect to the chassis. Now we have assumed that the potential of the chassis is zero, while point C is at a potential of 50 volts less. This being the case, current will flow from A to C, the amount depending on

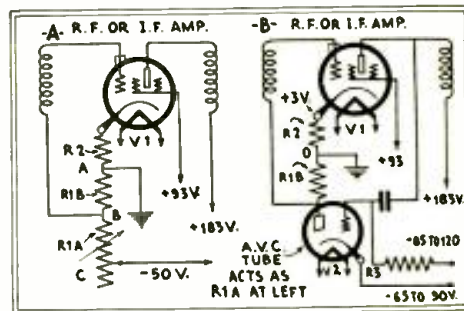

Fig. 2
The variable resistor shown in A is replaced by the A.V.C. tube illustrated in Fig. 2B.

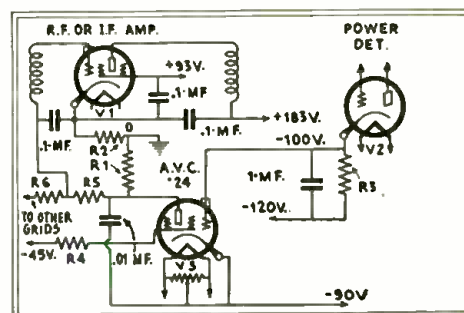

Fig. 3
Another circuit using a separate A.V.C. tube.

the total resistance between A and C. Now if we adjust the resistor R1A so that its resistance is infinitely high, very little current will flow, and the voltage drop across the resistor R1B will be negligible.

This being the case, the bias is almost exactly the same as the voltage across the cathode resistor, R2; and a state of maximum sensitivity results. Now if we lower the resistance of R1A, more current will flow due to the lowered resistance between A and C. This results in an increased current flow through the resistor R1B, with a corresponding increase of voltage across it. This voltage being applied to the grid of the tube reduces the sensitivity, and if the resistance of R1A is reduced to zero, the full 50 volts will be developed across R1B and applied to the grid, reducing the sensitivity to a minimum.

Both of these methods of controlling volume have been manually operated, and perhaps their relation to automatic volume control is not quite clear. Now, the purpose of A.V.C. is to provide a state of maximum sensitivity for the reception of weak signals and to cut down the sensitivity when a strong signal is being received, so that both are reproduced with substantially the same volume.

(Continued on page 177)

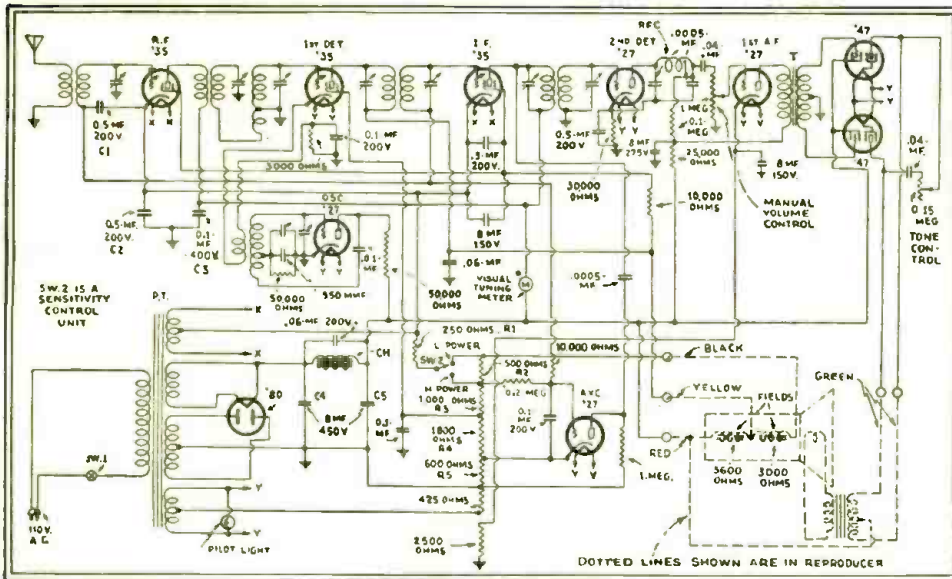

Fig. 4

Schematic circuit of the Apex No. 10 chassis used as a basis for discussion in this article.

This is the last of a series of articles dealing with the use of the analyzer in radio servicing. Particular emphasis is placed, in this discussion, on the manner in which radio sets are to be serviced.

By F. L. SPRAYBERRY

HOW TO USE A SET ANALYZER

In the two preceding issues of RADIO-CRAFT were described the technical details of a modern set analyzer. In the present article, the step-by-step processes involved in correctly operating such a test instrument in conjunction with the newest types of radio sets are given consideration.

Actual Measurements

Now for actual measurements to be made on a commercial receiver. Suppose we take a modern superheterodyne using variable- μ and pentode tubes and go through it with the set analyzer.

Figure 4 shows the circuit of a typical ten-tube receiver (the Apex No. 10 chassis). Such a circuit is an example of the receivers the Service Man is often called upon to service. We will assume that the tubes light, but we have no signal.

Give the aerial and ground connections a visual inspection to see if they are O. K. Next get out one of the analyzer charts (furnished with each analyzer) and follow the values shown in Fig. 5.

Insert the two leads from the plug into jacks 2 and 3 and plug the other end into the A.C. outlet which also connects to

the receiver. Line voltage will now be indicated on the 160-volt range of the A.C. voltmeter; record the value on the chart. Complete this portion of the record by filling in the position of the voltage tap to the primary of transformer. If line voltage is high, set this tap to the high position; if no tap is provided, install a voltage regulator.

Now remove the R.F. tube, placing the test plug in the receiver socket and the tube in the tester socket; turn the receiver "on" and the volume control on full; and fill in the chart as to position and type of tube. Turn the A.C. selector switch to the "H-111 4-volt" position; read on the 4-volt scale and record the indicated value in column 4. Now turn the master selector switch to the "P-K 300-volt" position; read the plate voltage on the 300-volt scale and record it in column 5 of the chart. Next, turn the master selector switch to the "GG-K 6-volt" position, reading the control-grid voltage as indicated on the 6-volt scale; record the value in column 6. Reset the selector switch to the "SG-K 120" volt position, at the same time pressing the small, green push button in the center of the selector switch; record this screen-grid potential in column 7. Reset the selector switch to the "K-H 60" volt position, recording the cathode voltage in column 8.

Next in line are the current readings. Reset the selector switch to the "G-12MA" position; read the screen-grid current on the 12-ma. scale; record in column 9. Reset the switch to the "P-120 MA" position; if no high current is indicated, reset to a lower scale. Reading the plate current on the 12 ma. scale; record in column 10. Leaving the selector switch in this position, turn the right-hand switch to the "down" position, at the same time noting

(Continued on page 179)

JEWELL RADIO SET ANALYSIS CHART													
OWNER _____										DATE OF TEST _____			
ADDRESS _____										PHONE _____			
NAME OF SET <u>Apex</u>										MODEL <u>10</u>			
NAME _____										SERIAL _____			
TUBE NO. IN ORDER TESTED	TYPE OF TUBE	POSITION OF TUBE IN SET	METER READINGS WITH JEWELL TEST PLUG IN SOCKET OF SET										
			OPERATING VOLTAGES					MILLIAMPERES					
			FILAMENT OR HEATER	PLATE OR ANODE	CONTROL GRID SPACE	NORMAL GRID-SCREEN	CATHODE TO HEATER	SCREEN GRID L. H. '80 PLATE	PLATE R. H. '80 PLATE	TUBE TEST	PLATE CURRENT CHARGE		
1	235	RF	2.3	175	2.3	65	.0	.7	4	6	2		
2	235	1st DET	2.3	185	7	69	14	.4	2	26	.6		
3	235	IF	2.3	175	2.3	65	.0	.7	4	6	2		
4	227	2nd DET	2.3	115	12		7.5		4	.5	.1		
5	227	1st AF	2.3	145	11		10		4.6	5.4	.8		
6	227	OSC	2.3	83	15-35		21		4.2	4.4	.2		
7	227	AVC	2.3	89	20		1.5		.0	.0	.0		
8	247	Power	2.35	255	18.5	265		4.5	21	28	5		
9	247	Power	2.35	255	18.5	265		4.5	21	28	5		
10	280	Rect	4.9					45	45				

* READING AS READ IS NOT TRUE GRID BIAS.

LINE VOLTAGE 115 POSITION OF VOLTAGE TAP _____ POSITION OF VOLUME CONTROL MAX

CONDITION OF "A" BATTERY _____ CONDITION OF "B" BATTERIES (1) _____ (2) _____ (3) _____

Fig. 5

Jewell Analyzer Service Chart. Readings are taken with the analyzer and recorded in a table, as shown above.

PRIZE AWARD

"UNCANNING" RESISTORS AND CHOKES

By R. W. Osland

THE writer has made numerous inquiries and finds that few Service Men seem to know that it is quite unnecessary to heat condenser, choke coil and transformer shield cans to remove the respective units where they are bound in the can by the tar compound usually used.

A very simple process is to set the entire unit into a receptacle into which has been poured sufficient gasoline or, preferably, carbon tetrachloride (or one of the cleaning fluids incorporating this chemical); the latter is better due to the fact that it is non-inflammable.

The procedure is illustrated in Fig. 1. Do not use this "stunt" where it is desired to save several condenser units which may be contained in the same can with the defective one it is desired to replace, as the chemical "cuts" the insulating paraffin. Transformers and choke coils may, by this process, be cleaned "right down to the bone," leaving a clean unit which is readily serviced for shorts or opens.

Of course, the same solution may be used over again several times. The job will be completed in about 5 hours.

HUM DUE TO ELECTROLYTIC CONDENSERS

By E. H. Weber

BEFORE looking or testing anywhere for the source of an A.C. hum in the Crosley Showbox or any other A.C. set

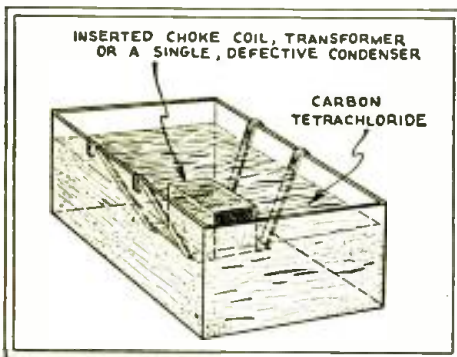

Fig. 1

Showing the brackets used to hold the condenser.

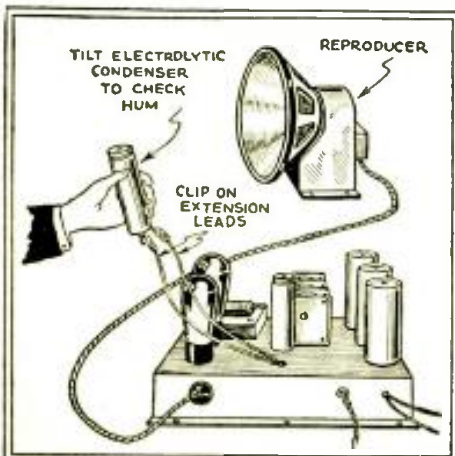

Fig. 2

Tilting the electrolytic condenser.

SHORT CUTS IN RADIO SERVICE

\$10 for Prize Service Wrinkles

Previous experience has indicated that many Service Men, during their daily work, have run across some very excellent Wrinkles, which would be of great interest to their fellow Service Men.

As an incentive toward obtaining information of this type, RADIO-CRAFT will pay \$10.00 to the Service Man submitting the best all-around Radio Service Wrinkle each month. All checks are mailed upon publication.

The judges are the editors of RADIO-CRAFT, and their decisions are final. No unused manuscripts can be returned.

Follow these simple rules: Write, or preferably type, on one side of the sheet, giving a clear description of the best Radio Service Wrinkle you know of. Simple sketches in free-hand are satisfactory, as long as they explain the idea. You may send in as many Wrinkles as you please. Everyone is eligible for the prize except employees of RADIO-CRAFT and their families.

The contest closes the 15th of every month, by which time all the Wrinkles must be received for the next month.

Send all contributions to the Editor, Service Wrinkles, c/o RADIO-CRAFT, 98 Park Place, New York City.

using the liquid-electrolytic condensers in the power pack, just tilt the set on edge and note whether the hum disappears or weakens. That the trouble is due to these filter condensers may be checked further by removing the condenser, soldering on longer leads as illustrated in Fig. 2 and tilting the condenser without moving the set; if the same change of hum volume is noticed, it proves that the trouble is in the condenser, (the change in filtering action is

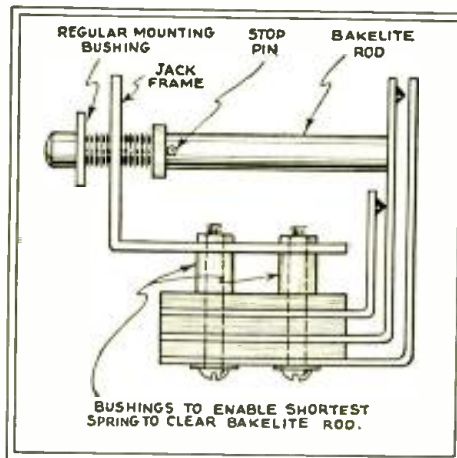

Fig. 3

An inexpensive "expensive" jack switch.

caused by the change in the position of the electrolyte when the condenser is tilted). Watch out for shocks!

A condenser showing this fault should be replaced.

JACKS AS SWITCHES

By LeRoy W. Johnson

RECENTLY I had need for a number of push-button type switches, and my solution to this problem of obtaining relatively expensive units may be of interest to other technicians.

A wholesale catalog offered a bargain in Yaxley S.P.D.T. switches; an old jack frame completed my kit of parts. The completed push-button switch is illustrated in Fig. 3.

Saw the jack frame to fit. Next, drill and tap the side of a piece of bakelite rod $1\frac{1}{2} \times \frac{1}{4}$ -in. in diameter. Into this hole is placed the stop pin, a small screw, the head of which has been cut off; the hole must be at a definite point to keep a steady tension on the rod to prevent it opening the normally closed circuit.

A SHOP CONTINUITY TESTER

By Thomas F. McTighe

A VERY good short-cut for use in the service shop is illustrated in Fig. 4.

The 25-watt lamp limits the current that may pass through the vacuum tube filament circuit or through the milliammeter circuit. This circuit arrangement may be used either as an ohmmeter or as a continuity tester. (As meter MA, the writer uses a D.C. voltmeter having a 7-volt range, 64 ohms per volt; rectifier V furnishes the requisite D.C. and enables ohmmeter readings up to 0.2-meg.; with the 5 ma. meter indicated in the

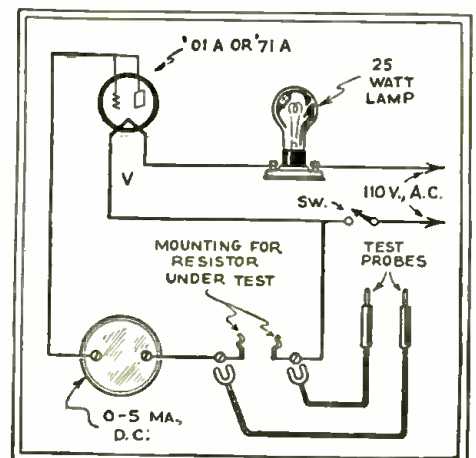

Fig. 4

Mr. McTighe's continuity tester.

figure, this range would be extended to 1. meg.)

The only caution is that *the radio set must be entirely disconnected from antenna, ground and the line circuit in using this device; otherwise, a short-circuit might result.*

CHASSIS HEATING SPEEDS SERVICE

By Norman H. Squire

OFTEN times, sets will perform O.K. until warmed up and then cut off; but if the chassis is removed from the case, this will not happen due to better ventilation. This effect is especially evident when the chassis has a metal cover-plate which must be removed to hunt the trouble.

I have often been able to get the trouble to show up by placing a radiant reflecting-type heater so as to heat the chassis by external means. This idea is illustrated in Fig. 5.

NEUTRALIZING D.C. RECEIVERS

By D. V. Chambers

THE writer has successfully used the adapter illustrated in Fig. 6 to neutralize D.C. receivers designed to be operated from the power circuit.

To remove the tube from the socket or to open its filament circuit in the usual manner would prevent the lighting of the remaining tubes in the series circuit. Consequently, the writer connects an external socket, B, in shunt with the adapter A. Thus, to complete the circuit, it is only necessary to plug into socket B a tube having similar filament characteristics to the regular tube in the set. As indicated in dotted lines only the plate, control-grid and negative filament leads of this tube's socket are wired through to the plug end of adapter A.

RECLAIMING TUBES

By R. D. Wills

AMONG my most useful service instruments is a 5-to-4 prong adapter which I use in the repair of burned out 5-prong tubes. The adapter is illustrated in Fig. 7. I have fused many tube filaments sim-

ply by plugging 5-prong tubes into the adapter which were supposedly burned out, and then plugging the 4-prong portion of the adapter into a 5-volt power tube socket.

The only precaution is to *watch closely* for as soon as the tube lights, it must be immediately removed; a slight jar may help to join the broken ends.

AN ANTI-HUM SHIELD

By M. Kikkebusch

TO reduce hum in certain types of receivers, the writer has found it necessary to shield the detector tube. For instance, in certain Day-Fan receivers of 8-tube type, a hum may be more pronounced with some type '27 tubes than with others. In the model mentioned, the '27 detector is of the grid-leak type and located only 2½ ins. from the '80 rectifier.

This "buzzy" hum is probably due to a "magnatron" effect, that is, the modulation of the detector electron stream by the rectifier.

Placing a piece of 3 x 5 in. aluminum or copper sheeting as shown in Fig. 8 eliminates this effect.

REDUCING HUM IN DYNAMIC SPEAKERS

By C. W. Palmer

A NUMBER of devices have been described in radio publications for reducing the hum in dynamic speakers; such as electrolytic condensers of high capacity, hum-bucking coils for the voice-coil circuit, resistors across the voice-coil, etc. In an article in the March 1931 issue of RADIO-CRAFT the writer described a number of these devices, giving the effective efficiencies of some of them. A system much more effective than previous arrangements was also explained.

As then mentioned, the hum originating in dynamic reproducers is almost always caused by a fluctuating current in the field actuating circuit, being picked up inductively in the voice-coil and thus vibrating the cone at the frequency of the fluctuation. While the current in the field circuit is pulsating D.C., the pulsations being 60 or 120 per second corresponding to the fundamental and first harmonic of the A.C. supply, the effect

in the voice-coil is the same as if A.C. of the same frequency were present.

Two obvious solutions to the difficulty are: first, to use a non-pulsating or steady D.C. in the field circuit and thus prevent any pickup in the voice coil, and second, to shield the voice-coil in some manner from the field supply. The first method is ordinarily out of the question because of economic reasons in the manufacture of the speaker and its power supply.

There are a number of dynamic reproducers in use which employ "dry rectifiers" to change the A.C. to D.C. for the field coil. There are also available a large number of "A" eliminators, relics of the days of "electrified" battery sets. An effective filter unit from a Sterling "A" unit was dismantled for use with a very "hummy" reproducer as shown in Figs. 9A and 9B.

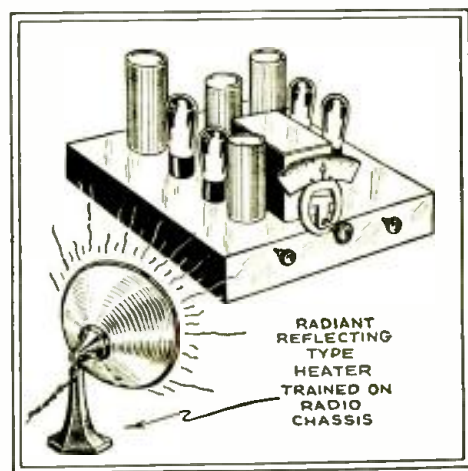

Fig. 5
Artificial heating of the chassis is easily accomplished with this novel idea.

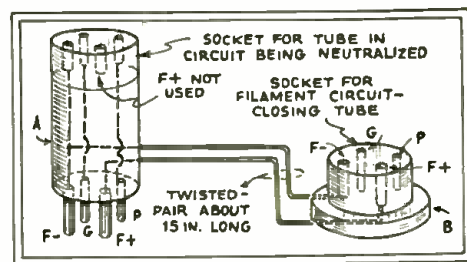

Fig. 6
Here's how to neutralize those D.C. receivers.

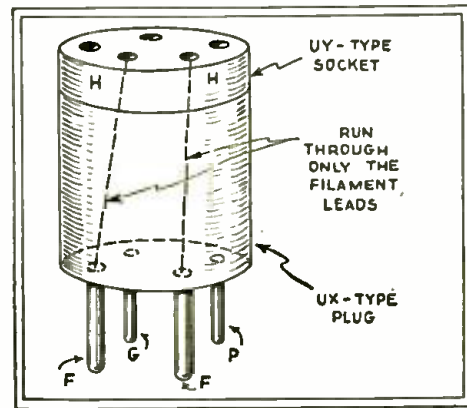

Fig. 7
Fusing burned out tubes. This idea may also be applied to ordinary incandescent lamps.

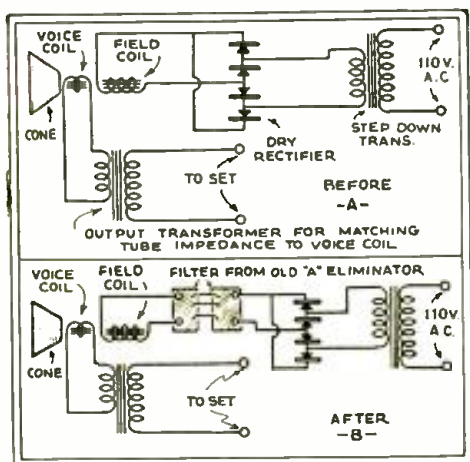

Fig. 9
Reducing hum in dynamic speakers.

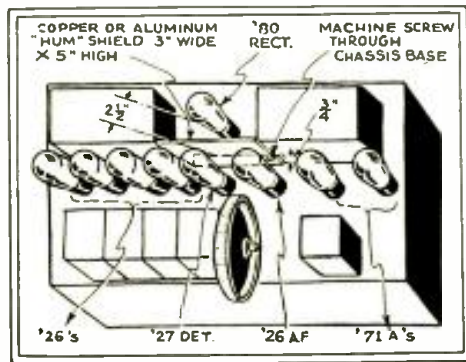

Fig. 8
An anti-hum shield.

cuit. Next to be inspected are the resistors and if these test up to par, I take the diagram and study it very closely for circuit peculiarities. What other parts I would substitute next all depends on the particular set. I shall now tell you about a few troubles I have encountered.

Philcos

The first case was a Philco 90 with type '45 output tubes; the report was "fading." All voltages tested normal but reception faded as soon as the chassis was touched, but when any test was conducted, the signal would rise to normal volume. The trouble was found in an open .01-mf. condenser, connected from detector plate to first A.F. control grid.

Another Philco set of this type played with low volume; turning the volume control did not change the volume; all voltages tested normal. The .01-mf. coupling condenser which is connected from the "detector-rectifier" output resistor to the manual volume control (whose movable arm is connected to "detector-amplifier" control-grid) was intermittently opening.

The owner of a Philco 41 D.C. reported the set slowly "dying" to a very low volume which could be brought up by turning the volume control; then, suddenly, the reception would rise to normal volume. Pulling on one of the condenser lugs would return operation to normal, only to again fade. Looking at the diagram, this condenser was found to be bypassing a 5000-ohm resistor in the detector control-grid return circuit. Replacement of the condenser solved the problem.

Many of the Philco 50 radio sets were reported to have low volume, distortion, circuit oscillation and hiss, but only after a tube was changed. The solution to this problem, which was quite a stumbling block for many Service Men, was to connect an additional .5-mf. condenser, from the movable arm of the volume control which connects to the R.F. cathodes, to the ground.

Stewart-Warners

Several Stewart-Warner 102-A radio re-

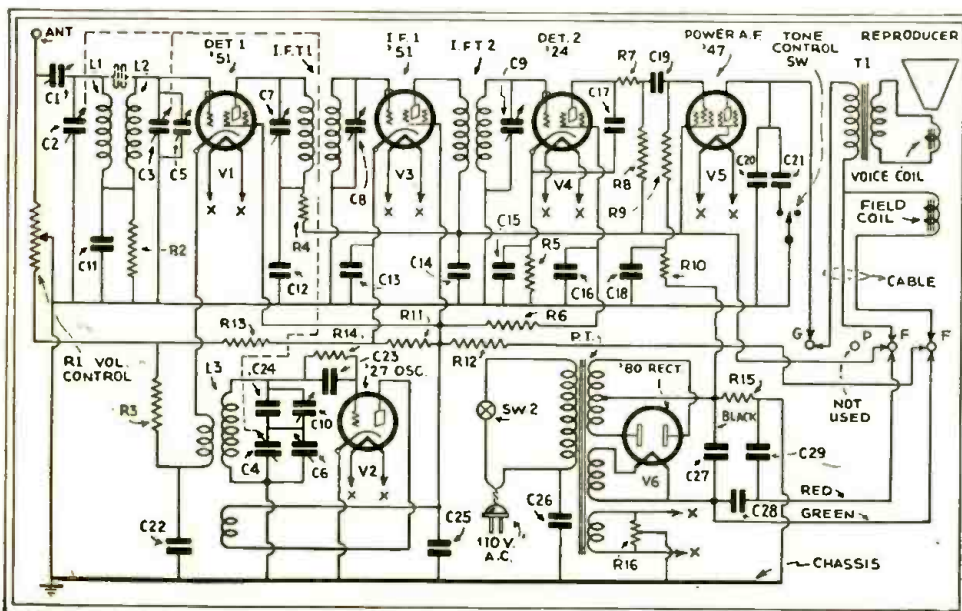

the set behaved normally.

Another cause of fading will be found in bad solder connection on the R.F. coils: slight tapping of the coil forms will locate the trouble if visual examination fails.

Should this set hum even after the two hum adjustments are adjusted properly and the Mershon condenser found O.K. then, connect a 1-mf. condenser from the first-A.F. cathode to ground; use leads as short as possible.

OPERATING NOTES

By Joseph X. Reilly

SEVERAL of the older Atwater Kent receivers are so constructed that the chassis contains all the operating dials which are manipulated from the front of the panel through holes cut out in the panel.

On one of these receivers the volume control did not function. Upon removing the set from the cabinet, the receiver operated in a normal condition for over three hours, but refused to function after this time when replaced in its cabinet. The removal and replacement of the receiver was repeated twice to determine whether or not something was shorted to the bottom of the cabinet which is of metal. Nothing doing; the set worked normally out of the cabinet, but had very poor volume in the cabinet.

The following procedure was then followed: The chassis was placed in operation out of the cabinet and then placed in the cabinet *while the set was working*. This, of course, was done very slowly until the entire receiver was in its cabinet—the set still worked O. K.!

Now, one by one the bolts holding the chassis to the cabinet was placed in position, and when the first one on the right-hand side was tightened, reception ceased.

The bolt was loosened again and reception became normal. A very close inspection revealed the fact that the volume control was placed on the chassis and one of its wires was bare at the point where it entered the volume-control unit.

After this was taped and tucked away, the short to the cabinet was eliminated.

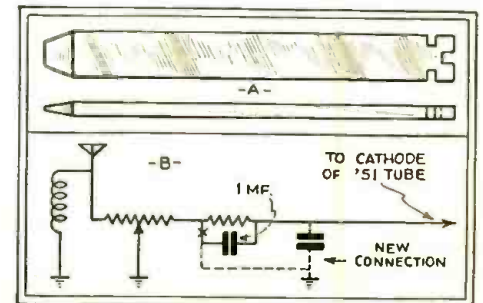

Fig. 2, left

Schematic circuit of the Bosch 31 receiver. In one case, an intermittently open screen-grid resistor, R12, caused fading. In another case, the second-detector screen-grid resistor caused similar symptoms.

Fig. 3, above

At A, the device used in the pulling operation; at B, the position of the condenser causing the trouble.

ceiver circuits "oscillated" on all stations. A check showed all voltages O.K. Resistance and condenser-short tests did not indicate any trouble. An 0.1-mf. condenser bypassing a 500-ohm cathode series resistor in the type '51 tube circuit was open and required replacement. The position of this condenser is indicated in Fig. 2B.

Low volume on a type R-102 D.C. (line) receiver was traced to an open 2 meg., ½-watt resistor located in the screen-grid circuit of the second-detector tube. This resistor was replaced with one of 1-watt rating.

Atwater-Kent

A great deal of annoyance was had, with an Atwater Kent 84 D.C. (line) receiver. All tests of voltages showed O.K., yet the set was playing with low volume. This set uses an I.F. "stopping" choke, which is located between the I.F. stopping condenser and one end of the volume control. The wire used is very fine; inspection showed that it had broken off close to the soldering lug.

Amrad 81

One of the most peculiar troubles regarding an Amrad 81 had to do with the complaint that after the set had been playing for three or four hours the program would start to fade. The chassis was "pulled" for shop test but during a whole week, it was impossible to make the fading condition appear. The set was brought back and the next day the customer called to report that the fading still existed! So, the set was watched, undisturbed, in the customer's house; at the end of five hours the set started to fade at one-minute intervals. Analyzer readings showed no plate voltage on the detector tube. At first it was thought to be the detector bypass condenser but when this was replaced the set still faded. So the only trouble could be the audio .5-mf. coupling condenser, which has two yellow leads coming from the bypass-condenser block. After these two leads were cut from the block and a new coupling condenser connected externally

CLARION DE LUXE MODELS AC-280 AND 25-280 12-TUBE SUPERHETERODYNE

(Four, type 46 tubes in double push-pull; mute switch; dual reproducers; twin-triode duo-diode second-detector combined with delayed A.V.C.)

One of the newest of Transformer Corporation of America's "Clarion" line of radio sets is the DeLuxe Model 280 superheterodyne, listing for less than seventy dollars, which incorporates a number of interesting circuit variations with which the Service Man must acquaint himself; these new circuit "kinks" are evident by reference to the schematic circuit.

The component characteristics are as follows: Resistor R1, manual volume control, 0.75-meg.; R2, tone control, 0.1-meg.; R3, 500 ohms; R4, R8, 10,000 ohms; R5, 0.1-meg.; R6 1. meg.; R7, 3/4 meg.; R9, 8,100 ohms; R10, 1,000 ohms; R11, 300 ohms. The field coils measure 400 ohms each; choke Ch., 400 ohms.

Condensers C1 to C3 are the tuning units (they are shunted by trimming condensers which do not appear in the schematic circuit); padding condenser C4 also is shunted by a trimming condenser; C5, C15, C21, 0.1-mf.; C6, 50 mmf.; C7 to C10 are the I.F. trimmers; C11, .25-mf.; C12, .02; C13, C18, 1. mf.; C14, .001-mf.; C16, 8 mf.; C17, 2 mf.; C19, .12-mf.; C20, .11-mf.

Operating tube characteristics (Line potential, 115 V., vol. control R1 full on; mute switch Sw. 2 "out.") Filament potential, V1, V3, V4, V5, V6, 2.2V.; V2, B7, 2.3 V.; V8, V9, V10, V11, 2.4 V.; V12, 4.9 V. Plate current, V1, 250 V.; V2, 242 V.; V3, 110 V.; V4, 249 V.; V5, V6, 0 V.; V7, 237 V.; V8, V9, V10, V11, 245 V.; V12, 340 V. (each plate). Control-grid potential, V1, V4, 0.2 V.; V2, 4V.; V3, .05-V.; V5, V6, 2 V.; V7, 3 V.; V8, V9, V10, V11, .32 V. Cathode potential, V1, V4, 4 V.; V2, V5, V6, 5 V.; V3, 0 V.; V4, 4 V.; V7, 9.5 V. Screen-grid potential, V1, V4, 77 V.; V2, 85 V.; V3, V5, V6, V7, 0 V. Plate current (normal), V1, 4 ma.; V2, 0.25-ma.; V3, 8 ma.; V4, 2 ma.; V5, V6, 0 ma.; V7, 3 ma.; V8, V9, V10, V11, 20 ma.; V12, 108 ma. (per plate).

When a strong signal is being received and a long antenna is being used, or the volume control is set too high, the result may be tube overload. This may take the form of a whistle when tuning across the sidebands.

A good ground is important to satisfactory operation.

The model AC-280 chassis is designed for operation on 110 to 120 V., 50 to 60 cycles; the model 25-280 operates on 110 to 120 V., 25 to 40 cycles.

There are four construction details of outstanding interest, to wit: "delayed" automatic volume control; double push-pull power amplification (using, incidentally, the new type 46 tubes); twin-triode duo-diode second-detector, and; dual repro-

ducers.

In the second-detector stage two type '27 tubes are used in double diode connection. In this circuit the detectors are used as ordinary two-element rectifiers of the R.F. signal fed to their control-grids, which are connected in push-pull. The plates are connected in parallel, the audio component dividing into two paths.

One circuit for the A.F. is through condenser C11 to ground; the other follows the common R.F. and I.F. cathode path through R3 and then to ground. The latter connection has an additional path through C14; then, there is one circuit to ground through R7, and another through RFC, C15 and R1. The latter connection (at the tap between C15 and R1 forms part of another path which is the control-grid return circuit of V1 and V4. (This return circuit includes a filter, R6 and C21.)

Automatic volume control is secured through the pulsating D. C. (rectified R.F.) drop across R7. The higher powered stations with strong R.F. carriers when tuned in cause greater pulsating D.C. to flow from the detectors' plate-cathode, through R7, to ground; thus, the drop across R7 is increased.

This increased potential is impressed on the control-grids of the R.F. and I.F. tubes, V1, V4, increasing their negative bias; thus, the sensitivity is automatically reduced.

In the instance of a reduction of signal strength, the R.F. input to detectors V5, V6 will be lowered, resulting in a reduction of the amount of pulsating D.C. flowing through R7; this lowers the bias potential applied to the control-grids of V1 and V4 and so increases the sensitivity of the receiver to maintain even A.F. output.

Now, the resulting design is such that if the set is tuned with normal speed, there will be little or no between-station (or "A.V.C.") noise—the A.V.C. action is delayed (due to the "time constant" of R7 and C14).

Incidentally, due to the anti-fading characteristic of the A.V.C. circuit, static may

appear to rise and fall in intensity during reception of a program; this is because the sensitivity of the set will be following the signal in and out of the noise level if the signal is fading.

To reduce to zero the sounds that are incidental to tuning in a station, mute switch Sw. 2 is operated.

The power rating of this set is 129 watts at 115 V.

Removing the tube shields may cause circuit instability.

The dual reproducers have dissimilar reproduction characteristics.

The trimmers of condensers C1, C2, C3 are located on the tuning gang; they range, in this order, from the front to back. The trimmer in shunt to C4 is located on the top of the chassis and directly in back of the tuning condenser gang. Trimmers C7 and C8 are located on the front surface of I.F.T. 1 (which is nearest the tuning condenser gang; the upper adjustment is C8 and the lower one, C7. Trimmers C9 and C10 are located on the left surface of I.F.T. 2 (at the extreme left of the chassis); the upper adjustment is C9 and the lower one is C10.

Since poor tone quality will result if the tuning is not exactly "on the button," instruct the customer to first reduce the volume control to the point of lowest audibility before making the final tuning adjustment for the "center" of the signal.

Do not forget that due to the use of an I.F. of 175 kc. there may be a heterodyne whistle at 700 kc., the fourth-harmonic, under exceptional conditions.

The R.F. circuits are resonated at 600 and 1400 kc. The factory service department states: "The most important advice we can give in regards to the adjustment of trimmers would be 'don't make 'em'."

Due to the fact that it is absolutely essential for good tone quality that the reproducer field and voice coils be correctly connected we reproduce a detailed illustration of the connections for these two devices.

To test the ground connection, connect a 100 W. lamp in series with the ground and each side of the 110 V. light-line, in succession. The lamp should light brilliantly. If the lamp does not light at all, it indicates "no ground" and if it lights, but dimly, it indicates a high-resistance ground which must be corrected. Where the line test indicates that no ground on power lines is being used, the local power company should be notified, as this condition generally results in hum and background noise in the receiver. The best ground is a cold-water pipe connection.

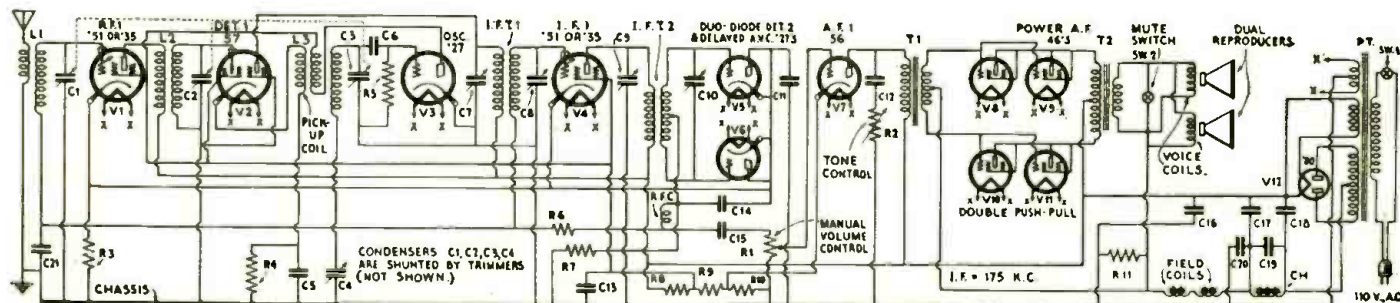
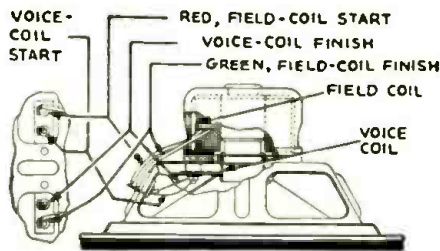

MAJESTIC 9-TUBE SCREEN-GRID SUPERHETERODYNE, A.V.C. MODEL 290 CHASSIS

(Madison Model 291, Adams Model 293 and Monroe Model 294 receivers

incorporates silent tuning and new tube types.)

The circuit in the Model 290 chassis follows in general the connections employed in the earlier models 200, 210 and 220 chassis.

Following are the electrical characteristics of the components of this receiver.

Resistor R1, manual volume control, 25-meg.; R2, noise suppressor, 6,000 ohms; R3, tone control, 50,000 ohms; R4, R8, R14, 0.1-meg.; R5, R9, R10, R11, R12, R13, 0.5-meg.; R6, 5,000 ohms; R7, 10,000 ohms (12,000 ohms, in a few early models); R15, 2,000 ohms; R16, 400 ohms; R17, 700 ohms; R18, 180 ohms; R19, 18,000 ohms; R20, 2,400 ohms; R21, 6,700 ohms; R22, 230 ohms; R23, hum control, 20 ohms, center-tapped. The field coil has a resistance of 1,260 ohms.

Tuning condensers C1, C2, are the R.F. tuning units of 18-363.4-mmfd. and condenser C3 is the oscillator tuning unit of 21-335 mmfd.; C1A, C2A, R.F. trimmers, 20-30 mmfd. and C3A, oscillator trimmer, 20-40 mmfd.; C4, C5, C6, C7, I.F. trimmers, 28-190 mmfd.; C8, 10 mf. (electrolytic); C9, C11, C13, C15, .25-mf.; C10, .05-mf.; C12, 0.1-mf.; C14, C16, C17, C19, C22, C23, .01-mf.; C18, C21, 500 mmfd.; C20, C24, .03-mf.; C25, C26, 8 mf. (electrolytic); C27, 7 mf. (electrolytic); C28, .001-mf.

Condensers C9 to C13 are located in one shield can; units C22, C23, C24, C28 are located in another.

The aligning condensers for this receiver are located on top of the condenser gang. The oscillator is designed to dispense with the "padding" unit required in earlier circuit arrangements.

The current consumption of this receiver is 75 watts.

Operating tube characteristics follow (line potential, 115 V.; silent-tuning control all the way clockwise; all D.C. voltage readings are to ground):

Filament potential, all tubes, 2.5 volts; plate potential, V1, V2, V4, 265 V.; V3, 90 V.; V5, 0 V.; V6, 155 V.; V7, 240 V.; V8, 85 V. Cathode potential, V1, V4, 3 V.; V2, 6 V.; V3, 15 V.; V5, V8, 0 V.; V6, 90 V. Plate current, V1, 4.4 ma.; V2, 3 ma.; V3, 1.6 ma.; V4, 5.8 ma.; V5, 0 ma.; V6, 0.6-ma.; V7, 28 ma.; V8, 1.4 ma.; V9, 70 ma. (total). Screen-grid potential, V1, V2, V4, 90 V.; V6, 135 V.; V7, 265 V.; V8, 0 V. Screen-grid current, V1, 1.0 ma.; V2, 0.6-ma.; V4, 1.5 ma.; V6, 0.1-ma.; V7, 7 ma.; V8, 0 ma.

To eliminate background noise while tuning, some receiver models incorporate a "mute tuning" switch; to eliminate the need for this manual operation there was developed the "synchronous silent tuning" circuit which is incorporated in the model 290 chassis. To obtain this action a "synchro." tube, V8 in the diagram below, is connected to control the plate-current cutoff of the first A.F. tube V6.

The synchro. tube V8 obtains its plate supply through resistor R6, which also is in the control-grid circuit of A.F. amplifier V6. Tube V8 obtains its control-grid potential from the A.V.C. circuit.

Therefore, when a station carrier is not tuned in, there is no A.V.C. potential and hence the potential of the control-grid of V8 is approximately zero voltage. This causes the plate of V8 to draw current through resistor R6. Now, the voltage drop across this unit biases the control-grid of V6 so high that V6 is "blocked."

On the other hand, when a station is tuned in, an A.V.C. potential develops across load resistors R13 and R14 (in the anode-return circuit of the diode tube V5); this A.V.C. potential is impressed in the form of a negative bias on the control-grid of V8.

The plate of V8 now draws little or no plate current and hence the bias across R6 disappears, leaving nothing but the normal operating bias on V6.

In this condition the entire set is operative just as though there were no synchro. tube in the circuit. In fact, it is possible after tuning in a station to remove the synchro. tube without noticing any difference. On the other hand, if this tube is removed when a station is not tuned in, the customary inter-station noises are heard.

Because of the variation in antennas, and noises in different locations, it is necessary to provide a control to govern the point at which the synchro. tube takes hold. Potentiometer R2, the "noise suppressor," is therefore included in the screen-grid circuit of V8.

In correctly setting the value of R2 the following steps should be followed.

(1). Set the suppressor knob to the position of no suppression (full clockwise, facing control);

(2). Tune the receiver to a position off the setting for a station and preferably near the low-frequency end of the dial;

(3). Next, turn the volume-control resistor R1 full on. In this position noise will be heard in a degree dependent upon the location;

(4). Now, adjust the noise suppressor control by rotating counter-clockwise, slowly, until the noise just stops. It will be found that the noise drops out quite suddenly, making it desirable that the control be set only to the position required to take out the noise and no further counter-clockwise than necessary;

(5). Although the set now is in operating condition, it may be found that in some particular locations the noise is greater at one end of the dial than at the other, so that if the noise suppressor is adjusted to take out noise at the low-frequency end of the dial, some noise may come in at the high-frequency end. In this case, it is advisable to readjust the noise suppressor at the high-frequency end of the dial;

(6). The final step in operating this type of circuit concerns its adjustment for greatest sensitivity. When extreme distance reception is desired, without regard to the noise-level between stations, simply turn the "automatic synchro-silent tuning control" knob as far clockwise as possible.

The normal antenna length for this chassis is 40 to 60 feet. The reproducer is a type G-19-A unit having improved characteristics.

The variable-mu characteristic of the type 58 tube makes it particularly suitable as an R.F., first-detector, and I.F. amplifier. The type G-4-S spray-shield diode tube used as second-detector and A.V.C., V5, is similar in design to the type G-2-S tube (described in the May, 1932 issue of RADIO-CRAFT), except for the smaller dimensions of the G-4-S; also, the latter tube has a heater current rating of 1. A., against 1.75 A. for the former.

The initial bias on the control-grids of the R.F. and I.F. tubes is obtained from resistor R18; the bias for the first-detector is the drop across R17. To these three tubes is applied the A.V.C. bias potential which is developed across resistors R13 and R14. Resistors R5, R11, R4, and R12, are bypassed filter resistors.

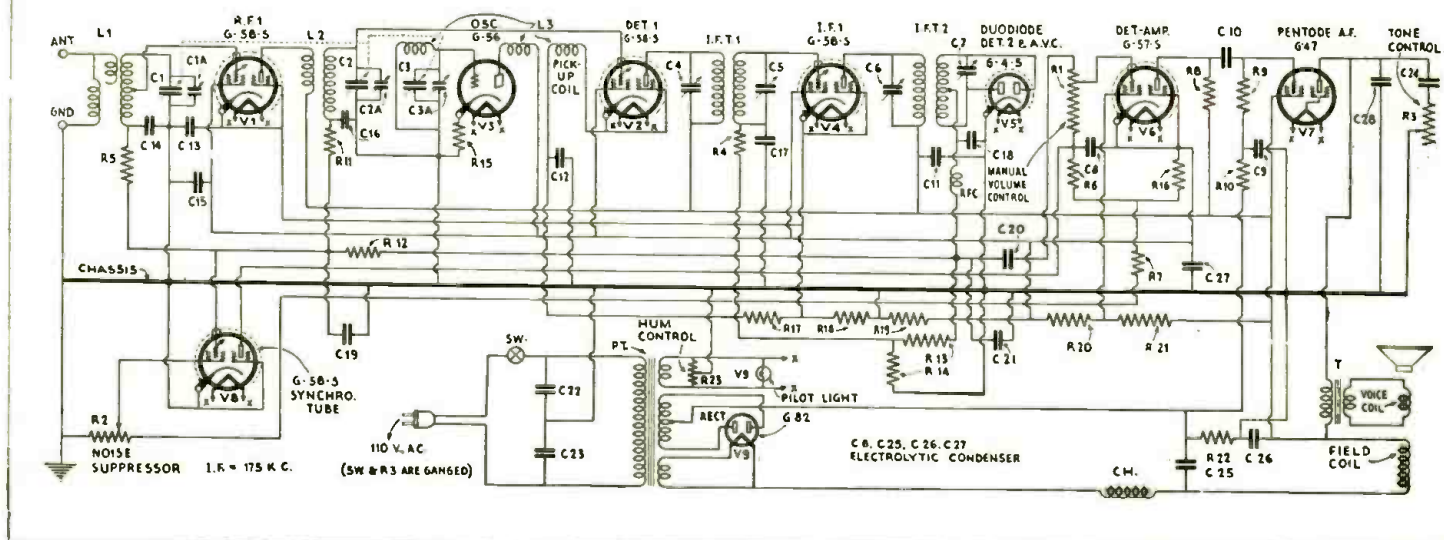

REDUCING NOISE WITH SHORT-WAVE COLLECTORS

By ARTHUR H. LYNCH*

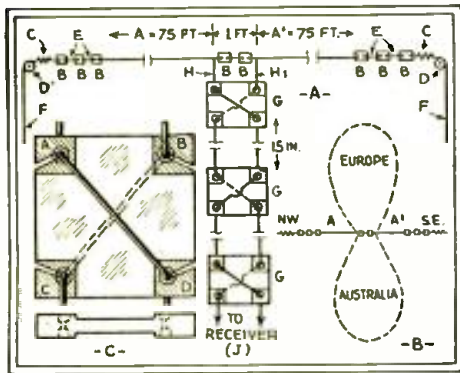

Fig. 1
At A, an "ideal" short-wave antenna; at B, its directional qualities; and at C, details of the transposition units.

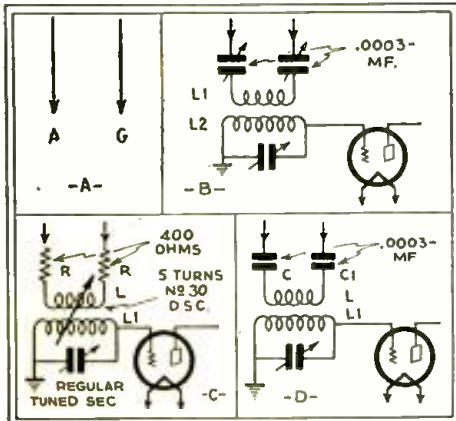

Fig. 2
Four different types of antenna-coupling systems. The one at C is recommended for all-around work.

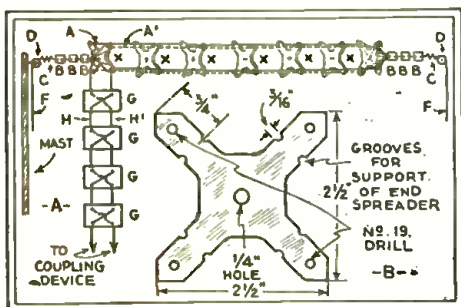

Fig. 3
A cage-type antenna at A; spreader details are at B.

WITHIN the past few months, much attention has been given to the reduction of background noise. Nearly all of the leading receiver manufacturers are announcing one system of noise reduction or another, and there seems to be no limit to the engineering involved in accomplishing this desirable end. Man-made static has long been the bugbear of distance reception, but it seems to be in for a real beating this time. The following is a survey taken by the author on a four-thousand mile automobile trip and expresses the views of the many experts interviewed on the subject. In this report, the Service Man will find important information and suggestions for increasing his revenue.

The Older Method of Attack

The older method of eliminating, or rather minimizing, interference consisted

in placing suitable filters at the source of the disturbance. This method, while undoubtedly the most desirable from the standpoint of efficiency, is not always the most desirable, in view of the considerable expense and trouble that may be incurred in locating the source.

Of late, an entirely different method of attack is being sponsored by many short-wave receiver manufacturers. This method, in brief, consists of so constructing the antenna system that the amount of interference picked up by the system is negligible in comparison with the signal to be heard. Let us see exactly how such an antenna system should be constructed.

The New Method of Attack

It is strange, but true, that the intelligent application of the information we have on receiving conditions has not been much in evidence until recently, but it is certainly coming in for its share of publicity now. There are some fundamental differences in the systems employed, however, and though an antenna system which is suitable for short waves can generally be used to good advantage with the broadcast band, *the reverse is not true*. In fact, most of the new antenna systems, designed for broadcast reception are not suitable for short-waves.

We are, for the moment, most concerned with the fundamental difference between the older and newer methods of noise reduction. Without going into a discussion concerning the whys and the wherefores, it is safe to consider the entire proposition from the point of view of important engineers and companies who have been applying the sound electrical principle upon which the system is based. Briefly, the various schemes, though they may differ somewhat in their application, are pretty much the same fundamentally. They are all predicated upon the use of a collector which is located in a place as free from interference as possible and then having a suitable connection (lead-in) from the collector to the receiver with due precautions taken to prevent the connector from acting as a partial collector.

In other words, the aerial is located as high and as far from other objects as possible and the lead-in is usually in the form of a shielded wire or shielded pair of wires, which is run from the aerial to the receiver or receivers. By suitable design, it is possible to operate a great many receivers from the same aerial, with better results and with less interaction

between the receivers than would be the case if several aerials were strung on the same roof.

Sensitivity and Noise

City dwellers have been the principal purchasers of radio receivers and it has been considered necessary for the city dweller to be provided with a radio receiver which he could move from one location to another without having to go to the trouble of putting up an outside aerial. In fact, there have been many instances where the outside aerial would not work very well because of the interference it would pick up. With this in mind, the engineers have made receivers extremely sensitive. Many of them are designed to pick up long distance with nothing more than a very small piece of wire and others which are not quite so sensitive do not require anything more than a piece of bell wire strung around the picture molding or under the carpet.

If aerials of this nature happen to be in the area of interference created by electrical devices operating in the building, there is no possible way of getting rid of the interference. However, provided with the same sensitive receiver, it is easy to understand that the same short piece of wire, placed *away* from the source of interference and connected to the receiver by a suitable lead, which would not pick up any of the noise, the desired signals could be picked up without the interference. Local reception would be much better and long distance which would be intolerable otherwise could be made pleasant. Several important companies are now offering systems which have been designed to accomplish this result.

All the systems offered at present are very effective on the broadcast wavebands, but very few attempts have been made to supply the same service for that rapidly growing list of short-wave enthusiasts. Here, the live Service Man has a rare opportunity.

One of the largest manufacturers of combination broadcast and short-wave receivers in the country told me that there was a great deal of bad feeling, on the part of purchasers of combination receivers, due to the fact that they were not able to make the receivers live up to the advertising which had been used to introduce them. Not that the receivers, under suitable conditions, would not live up to the claims, but when placed in locations where the background noise was

(Continued on page 184)

*President, Lynch Mfg. Co.

RADIO-CRAFT KINKS

Practical Hints From Experimenters' Private Laboratories

PRIZE AWARD

A POTENTIOMETER-TYPE VOLTMETER

By Crawford Cooper

In order that a radio set may function at maximum efficiency, it is necessary that the voltage of the component parts be correct, in so far as it is possible to make them. I find that the best voltmeters available for this purpose fall far short of the ideal in some respects; their readings are low because of the current drain of the meter. This is more noticeable in the later model receivers of the "mantel" type, because of the common use of the Loftin-White circuit in the audio end.

Since plate resistors have values varying between 100,000 and 300,000 ohms, it can easily be seen that the current drawn by the best of test meters causes considerable error in the readings; a current drain of .25-ma. sometimes causing an error of 50 to 75 volts!

We know that the operating voltage of the '24 is nearly 180 volts, but when the voltage is measured through the series resistor, our best meters do well to show an indication of about 30 volts. This is confusing at the best, and it is sometimes a great obstacle in the correct adjustment of the receiver in question. To be in a position to know the correct voltage applied between any two points in a circuit, the author uses the method outlined diagrammatically in Fig. 1.

It is nothing new in the radio world, but it may seem new to those not familiar with the potentiometer method of voltage measurement. It is simply this: using a foreign variable voltage supply to actuate the voltmeter, and a sensitive indicator to tell when our voltmeter is reading the correct voltage, the current through the indicator is *balanced out*, so that the voltmeter consumes no current, and hence the correct value of voltage is indicated.

To operate the device (Fig. 1) connect point A to the positive terminal of the external source of voltage and point B to the negative terminal of the source. Point D connects to the cathode or negative-filament terminal of the tube under test and C to the point whose voltage is desired, such as the plate or grid of the tube. The voltmeter range is then selected as usual; the galvanometer G should now show a small reading. Move the tap switch of the potentiometer toward the positive end until the galvanometer reads reversed and then move it back (toward the negative end) one notch. Now press button No. 1; this makes the galvanometer read higher; adjust the 500-

\$5 for a Practical Radio Kink

As an incentive toward obtaining radio hints and experimental short-cuts, "Radio-Craft" will pay \$5.00 for the best one submitted each month. Checks will be mailed upon publication of the article.

The judges are the editors of "Radio-Craft" and their decisions are final. No unused manuscripts are returned.

Follow these simple rules: Write, or preferably type, on one side of the sheet, giving a clear description of the best radio "kink" you know of. Simple sketches in free-hand are satisfactory, as long as they explain the idea. You can send in as many kinks as you wish. Everyone is eligible for the prize except employees of "Radio-Craft" and their families.

This contest closes on the 15th of every month, by which time all the Kinks must be received for the next month.

Send all contributions to Editor, Kinks Department, c-o "Radio-Craft," 98 Park Place, New York City.

tentiometer again adjusted to zero. This latter adjustment is hardly necessary for ordinary work and if the operator is not careful, the galvanometer may burn out.

Now rear back on your dignity and read the voltage on the voltmeter and *know* you are right.

List of Parts

The values of the component parts used in this tester are as follows: Resistors R1, R2, R3, R4, R5, R6, R7, R8, R9, 5,000 ohm, 5 watt units, wire wound. In lieu of the single resistors, one 45,000-ohm unit tapped every 5,000 ohms may be used. In any event, they should be able to carry 10 ma. continuously and have an accuracy of better than 10 percent; R12 is a 1. megohm, 2 watt carbon resistor; R11 is a .5-megohm, 2 watt carbon resistor; R10 is a 10,000 ohm, 1 watt carbon resistor; G is a 0-1 ma. milliammeter or any low-current movement that may be available.

(This measurement, as stated by the author, is not new, having been used for many years in electrical measurement laboratories for the calibration of standard voltmeters in conjunction with a standard cell. However, its application to radio work is novel and should certainly appeal to anyone who wants a real voltmeter and who is willing to spend three minutes to make an accurate reading.—Editor.)

RESISTOR CLIPS

By Clarence W. Trost, W9HMZ

THE writer submits the idea depicted in Fig. 2—it acts as a simple means of adapting the once popular (and of late much unused) Fahnestock clip.

The modern trend seems to be toward resistance coupled audio stages, and, consequently, resistor mounts are necessary. The curved section is bent up as shown; this permits the screw, used to fasten the clip to the panel or baseboard, to be inserted in the hole already in the clip.

Now, if the "hook" under the curved section be removed, another hole is available for under-panel wiring; or if it is left as originally designed, the "hook" may be used as a convenient soldering lug. Thus, a connection to the clip may be made directly without the necessity of having a nut and bolt to secure the soldering lug to the clip.

(Many readers seem to have simple ideas such as that described above but are (or seem afraid) to submit them because of the obviousness of the suggestion.

Simplicity, dear readers, is sometimes the mother of invention—so let's go to it.—Editor.)

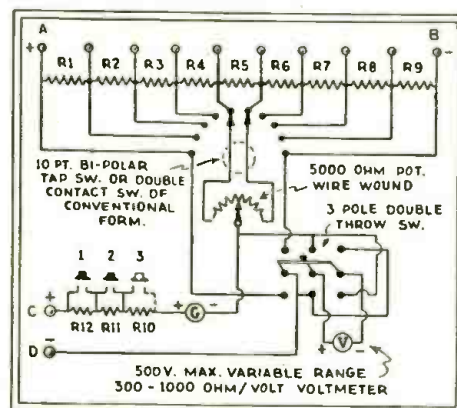

Fig. 1
The potentiometer-voltmeter

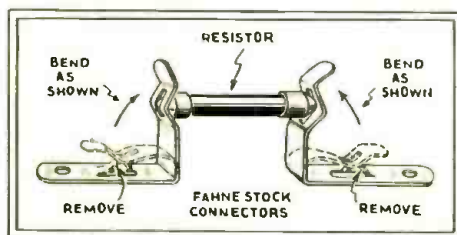

Fig. 2
A new type of resistor mount.

ohm potentiometer until the galvanometer reads 0 (zero). Then press button No. 2 and again adjust the potentiometer until the galvanometer reads zero. This must be done very carefully as the accuracy of the entire measurement depends upon this adjustment.

If additional sensitivity is required, button No. 3 is pressed and the 500-ohm po-

THE RADIO CRAFTSMAN'S PAGE

The Bulletin Board for
Our Experimental Readers

"TUBELESS" RADIO A HOAX?

In response to numerous inquiries from interested readers of *RADIO-CRAFT* magazine, we publish below and without bias a series of quotations from correspondence between *RADIO-CRAFT* investigators and representatives, concerning the "tubeless" radio set of Ernest Patrick of Columbus, Ind. This set is illustrated in Fig. A.

According to one correspondent, the receiver, which measures 6 x 18 x 12 ins. deep, uses a crystal detector (probably Carborundum) and several other crystal units in electromagnetic fields as R.F. and A.F. amplifiers. There are three tuned circuits, single-dial controlled. The output feeds a standard dynamic reproducer.

O.R.S.M.A. Member No. 4566; Columbus, Ind.; "I have never seen this set outside of the picture that appeared in *Radio World*. Some people that say they have seen this set say they did not hear it work; others say that it has no volume. At present, I have my doubts if this set really exists."

O.R.S.M.A. Member No. 4614, Columbus, Ind.: Mr. Patrick states that as soon as the patent situation clears "we will get all the details." All of which seems peculiar, inasmuch as a patent pending case is better protection than one on which the patent has been issued. In conclusion, we must answer both yes and no, when asked as to whether the set is really worthwhile.

Mr. Patrick: "I don't have anything to say about the tubeless radio patents as there is a concern in Chicago (Strotz) that have purchased the patents from me a long time ago."

A Chicago representative: "I have been in touch with the Strotz Tubeless Radio Company for the last six months but have not been able to see the set. I have never seen anybody that has actually seen the radio and they won't release any dope on the set. All they have, apparently, is a small office in an office building; and I am sure they do not have a factory."

Strotz Tubeless Radio Corp.: June 23rd: "A technical story will not be released until the middle of next month."

We feel perfectly safe in assuring the Strotz corporation that every reader of *RADIO-CRAFT* will be deeply interested in this promised story.

IMPORTANT NOTICE

In the interest of those readers who do not like to mutilate this magazine, we have asked our advertisers not to place coupons in their advertisements.

Instead of the usual coupons, you will find a number of convenient post cards inserted between the last page and the back cover of this magazine.

This new service will save you time and work. No need to cut coupons, nor is it necessary to hunt for and address envelopes. Moreover, the space for your name on a coupon is usually so small that the advertiser is often not able to make out your writing and then you wonder why you do not get the literature sent for.

Then, last but not least—the postage for a postal card is only 2c whereas a letter now costs 3c.

Read the advertisements and then turn to the page containing the special postal cards. Detach, fill out and mail the card of the advertiser whose literature or offers you want to have sent to you.

Mail your card today! Show the advertisers that you appreciate their cooperation and thoughtfulness.

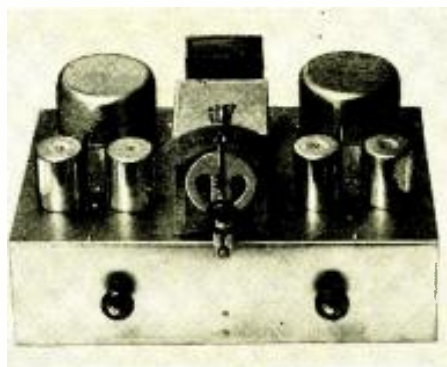

Fig. A

Is the "tubeless" radio here?
Photograph courtesy Strotz Tubeless Radio Corp.
203 North Wabash, Chicago, Ill.

5- OR 10-KC. MODULATION— WHICH?

Technicians will be interested in the following data which brings up the subjects of receiver selectivity, side bands, and percent of modulation, discussed so often in this department.

A publicity release is quoted as follows: "A new radio transmitter of radical design will shortly be placed on the air by station WPEN, Philadelphia. The

tubes are rated at 100 watts, but by "Class B" amplifier design the output power rating may be placed at 250 watts.

"According to engineers of the RCA Victor Company, the new station will send out unusually high-quality transmission with a range of frequency response of from 30 cycles (which is equivalent to the low organ notes) to 10,000 cycles (10 kc., which is equivalent to the higher harmonics of stringed instruments). The design of the new transmitter provides 100% modulation, which means that the instantaneous power may be as great as four times the power rating of the station, thus obtaining the maximum coverage with the licensed power of the transmitter.

"Automatic crystal control will keep the transmission well within the new 50-cycle adherence to wavelength prescribed by the new ruling of the Federal Radio Commission. In fact, with the aid of a thermostatic regulator which automatically keeps the crystal at constant temperature, it is expected that WPEN will normally be held to within 0.0006-percent of its assigned wavelength."

Concerning this design, RCA Victor writes to us as follows: "We have for some time been manufacturing transmitting equipment which will permit audio frequency response up to at least 10,000 cycles.

"There is no regulation stating that radio stations shall limit their transmission to the 5 kc. spacing used by the Radio Commission. In fact, the Radio Commission has carefully spaced local stations 30 to 50 kc. apart. In other words, it is usually so arranged that a 10 kc. separation exists between a local station and a distant one whose signal strength is insufficient to cause interference."

From the Department of Commerce, Radio Division, comes a letter containing the following comment: "The Commission has no Rules and Regulations specifying the limits of the side bands that may be transmitted by broadcast stations so long as such side bands are produced by the usual broadcast transmission such as music or speech.

"The relative amount of energy in music or speech above 5,000 cycles is very low and even though a transmitter may have the capability of transmitting frequencies up to 10,000 cycles, the energy in the side bands above 5,000 cycles is so low that it has not been found necessary to promulgate any regulations along this line."

RADIO-CRAFT'S INFORMATION BUREAU

SPECIAL NOTICE TO CORRESPONDENTS: Ask as many questions as you like, but please observe these rules:

Furnish sufficient information, and draw a careful diagram when needed, to explain your meaning; use only one side of the paper. List each question.

Those questions which are found to represent the greatest general interest will be published here, to the extent that space permits. At least five weeks must elapse between the receipt of a question

and the appearance of its answer here.

Replies, magazines, etc., cannot be sent C. O. D.

Inquiries can be answered by mail only when accompanied by 25 cents (stamps) for each separate question.

Other inquiries should be marked "For Publication," to avoid misunderstanding.

PHILCO "TRANSITONE" MODEL 7 AUTOMOTIVE RECEIVER

(167) Mr. R. Bayer, Brooklyn, N. Y.

(Q.) Please illustrate and explain the following construction features of the new Philco "Transitone" automotive receiver: Combination second-detector and A.V.C., using a pentode tube; combination first-detector and oscillator, and; automotive grid bias.

(A.) Our correspondent is interested in the Transitone model 7 set. The design of this chassis has undergone some change; the latest version is illustrated in Fig. Q-167. (The earlier instrument used a type '38 tube in the output stage and only 1. mf. as the bypass capacity around its grid-bias resistor; also, the antenna lead was not shielded.

In addition to the values shown in the diagram, the following figures are available: Condensers C1, C2, C3, 325 mmf.; C1A, C2A, C3A, C5, C6, C7, 50 mmf.; C4, 250 mmf. The 225-ohm bias resistor of I. P. 1, tube V3, is not bypassed.

The blue-white lead of the receiver must be connected to "B + 135 V.," and the green-white lead to "B + 67½ V.," The black-white wire is the "A" lead which must be connected to the 10 A. fuse and from there, a single lead which is supplied, must be run to the car battery. The "B -" of the batteries must be connected through the 1 A. fuse to the battery side of the 10 A. fuse.

Do not use shielded antenna lead-in wire as the losses are too great. The most suitable lead is 7 m/m Beldenlac shielded secondary cable.

Adjust the trimming condensers at 1400 kc. and "padding" condenser C4 at 700 kc. The former frequency should be 140 on the dial.

Tube readings (taken to chassis and with "A + " grounded) are as follows: Filament potential, all tubes, 6.0 volts. Plate potential, V1, V2, V3, 129 volts; V4, 115 volts; V5, 125 volts. Plate current, V1, 2.8 ma.; V2, 0.8-ma.; V3, 2 ma.; V4, 6 ma.; V5, 7.5 ma. (approx.). Control-grid potential, all tubes, zero. Screen-grid potential, V1, V2, V3, 61 volts; V4, 50 volts; V5, 129 volts. Cathode potential, V1, V4, zero; V2 (with receiver tuned to 550 kc.), 6 volts; V3, 0.5-volt; V5, 11 volts. The total "B" drain of the set is about 20 ma.

The type 41 pentode is more rugged and

has about double the undistorted power output of the type '38 pentode. Therefore, the output transformer T in the later chassis design does not have the same characteristics as the unit (of the same code number) used in the earlier model.

Perhaps the two most important factors in obtaining high sensitivity in this chassis are correct alignment of the tuned circuits and the use of tubes of correct rating; the first point cannot be stressed too greatly.

By the use of bias resistors the need for a "C" battery is eliminated, bias being obtained from the "B" supply.

RCA VICTOR MODEL R-78

(168) Mr. V. Gorgione, Bronx, N. Y.

(Q.) Please advise whether it is possible

to connect a phonograph pickup to the new Radiola "Bi-Acoustic" superheterodyne?

(A.) In Fig. Q-168 are illustrated a number of connections of interest to technicians. (The complete receiver circuit is Data Sheet No. 72 in the August, 1932 Issue of RADIO-CRAFT.) These circuits are described as follows: A, connections for attaching a phonograph end-table, Model T-3; B, method of adding a portable turntable, Model PTT-23; C, connecting a magnetic pickup into the circuit; D, diagram in wiring up a short-wave converter, Model SW-2.

Due to the A.F. system of the receiver being designed to compensate for changes in the R.F. end of the set, its characteristics must be altered slightly for phonograph operation, as shown in Fig. Q-168. It is necessary to use

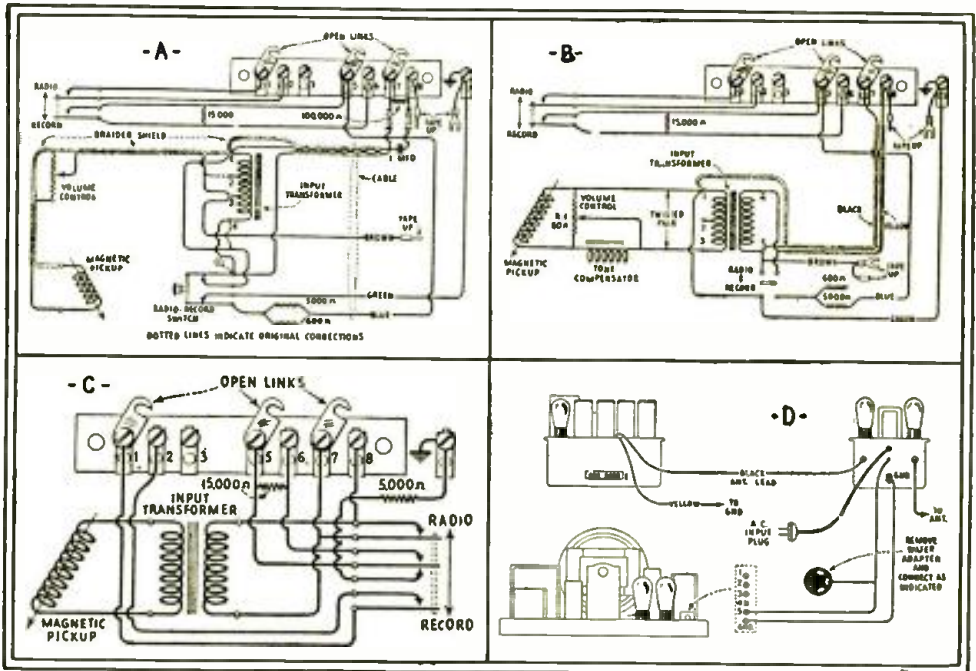

Fig. Q-168. External connections to the RCA Victor model R-78 receiver.

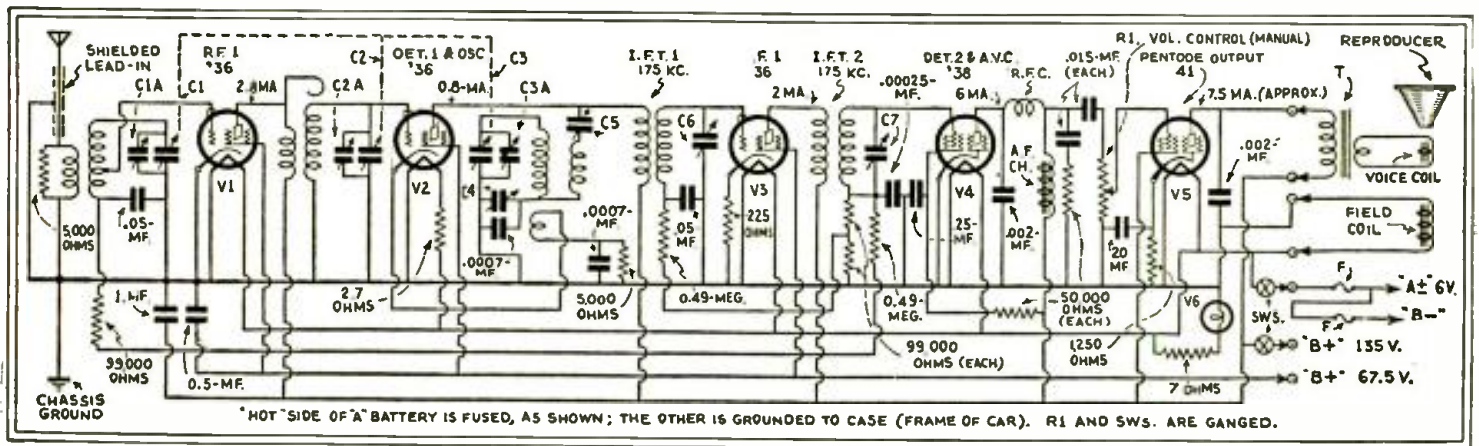

Fig. Q-167. Schematic circuit of the latest type Philco "Transitone" 7 receiver model. Note that the diagram provides for a pentode in the combination position of second-detector and A.V.C.; the output of this tube feeds special, improved type of "automotive" pentode having increased power output characteristics. An "automotive" screen-grid tube, V2, serves the dual functions of first-detector and oscillator; the high-potential end of the tuned circuit comprising condenser C3 is permitted to "float" (remain unconnected), as shown.

the auxiliary switches, resistors and condensers with the types T-5 and PT-33 units, as well as the complete switching system shown at C, when making connections to magnetic pickups. Also, the record volume control should be set at maximum and the volume adjusted by means of the "Radio" volume control. If the resulting degree of frequency compensation is too great (too many "highs" and "lows") this may be remedied by reducing the "Record" volume control setting and advancing the "Radio" volume control.

Note in D that in connecting the short-wave adapter to the Model R-78 receiver a wafer connection is not used; this is due to the output rectifier voltage being too high. This potential, from terminal No. 5, is about 230 V. and therefore suitable.

"THE PENTODE—A TRIODE"

(169) Mr. J. Escobar M. Manati, Puerto Rico. (Q.) The article, "The Pentode—A Triode," which appeared on Page 42 of the July issue of RADIO-CRAFT is of exceptional interest; however, it lacked certain details.

I would like to know if it is possible for you to furnish the values of the parts required to build up the circuit illustrated in Figs. 2 and 3?

(A.) It is regretted that this very necessary information was inadvertently left out of the original article; the data is published below.

Parts List for the Circuit of Fig. 2

- L1, Polymet Part No. TC 798;
- L2, Polymet Part No. TC 793;
- L3, Polymet Part No. TC 795, 20 hy.;
- C1, Polymet Part No. C-905, 2 mf.;
- C2, Polymet Part No. MC-1223, .015 mf.;
- C3, Polymet Part No. C-925, 2 mf.;
- C4, Polymet Part No. DR-252, 2 mf.;
- C5, C6, Polymet Part No. DR-254, 4 mf.;
- C7, Polymet Part No. DR-272, 2 mf.;
- PT, Polymet Part No. TF-774;
- T1, Polymet Part No. TA-737 (Single Button Microphone);
- T2, Polymet Part No. TA-734 (To Dynamic Speakers).

Parts List for the Circuit of Fig. 3

- T1, Polymet Part No. TA-738;
- T2, Polymet Part No. TA-704;
- T3, Polymet Part No. TA-706 (To Dynamics);
- PT, Polymet Part No. TF-774;
- C1, Polymet Part No. C 905, 2 mf.;
- C2, Polymet Part No. C 925, 2 mf.;
- C3, Polymet Part No. C 905, 2 mf.;
- C4, Polymet Part No. C 905, 2 mf.;
- C5, Polymet Part No. C 925, 2 mf.;
- C6, Polymet Part No. DR-252, 2 mf.;
- C7, Polymet Part No. DR-254, 4 mf.;
- C8, Polymet Part No. DR-254, 4 mf.;
- C9, Polymet Part No. C921, 1 mf.;
- R1, Electrad Potentiometer, 50,000 ohms;
- R2, International Part No. 2 MR4, 1500 ohms (in parallel);
- R3, International Part No. MR4, 30,000 ohms;
- R4, International Part No. MR4, 30,000 ohms;
- R5, International Part No. MR4, 5,000 ohms;
- R6, International Part No. MR4, 250,000 ohms;
- R7, International Part No. MR4, 2,000 ohms;
- R8, International Part No. MR4, 40,000 ohms;
- R9, Electrad Truvolt, 20,000 ohms (tapped);
- R10, International Part No. MR6, 500 ohms;
- R11, Electrad Potentiometer, 10,000 ohms;
- L1, L2, Polymet Part No. TC 793.

In Fig. 2 of the article is shown a simple microphone amplifier; in Fig. 3, a high-quality

Type Tube	How Used	Plate Volts	Screen Volts	Control Grid Bias	Recommended I R C Bias Resistor	Notes
56	Class "A" Amplifier	250		13.5	F-35-2700	
56	"C" Bias Detector	250		20	F-34-100,000	
57	Class "A" Amplifier	250	100	3	F-35-1000	
57	"C" Bias Detector	250	100	6	F-35-60,000	Plate coupling resistor should be 250,000 ohms, F-1-250,000
58	Class "A" Amplifier	250	100	3	F-35-270	
58	Super-heterodyne 1st Detector	250	100	10 Minimum		Cannot be used as ordinary grid bias detector
46	Class "A" Amplifier	250		33	F-1-1500	

Fig. Q-170. Grid-bias resistor values.

output design capable of much greater power output. By substituting a "vacuum tube" type of transformer as T1, either amplifier may be used in conjunction with a radio tuner chassis.

GRID BIAS RESISTORS

(170) Mr. Joseph H. Kranter, Peconica, Ill. (Q.) What are the resistor values to be used to obtain bias potentials for the new "superphonic" series of tubes?

(A.) There has just been released by International Resistance Co. a convenient tabulation of these values which we reproduce as Fig. Q-170.

The figures are for a single tube; for more, divide by the number of tubes (and multiply by the same figure for the power rating).

(Effective immediately, the following new type numbers will be used in designating IRC resistors.)

Old No.	Size	New No.
MF-4 1/2	1/2-watt	F-3/2
MF-4	1-watt	F-1
MR-4 }	2-watt	F-2
MR-5 }		
MR-6	3-watt	F-3

CHOKE COIL DESIGN DATA

(171) Mr. Vineto Solana, Albuquerque, N.M. (Q.) Please publish construction data for a 30-hy. choke coil.

(A.) We are fortunate to be able to present in Fig. Q-171 not only the particular information requested, but also complete data on the design of impedance units of other ratings. This excellent reference table is published by courtesy of National Radio Institute.

The wire sizes in this table are conservative and 10% more current can be passed continuously. Wire with thin insulation should be used to make an economical design. It is best to wind directly on the core, with just a single layer of tape between; increasing this insulation a little where the unit is to be used in high-voltage circuits. Wind the inductance over cotton tapes; these then may be fastened over the completed coil to hold the wires in position. Too much tape should not be used as this would cause undue heating, due to the lack of air circulation.

By using these figures as a basis of comparison, intermediate values of inductance may be built up to meet individual conditions. This data is useful in many ways; for instance, in

(Continued on page 188)

TABLE III

Current	Core	Capac-	Induct-	No.	Feet of	Resist-	Weight of	Core	Core		
Capacity	Size	ity	ance	Turns	Wire	ance	Copper	Long	Short	Pounds	
Amps.	Cross	Section	Henrys	(N)		(D.C.)		Piece	Piece		
0.05	1/2 x 1/2	—	0.5	1600	400	82.5	1.0oz	1/2 x 1.6	1/2 x .50	0.30	
				2300	615	127.0	1.5oz	1/2 x 1.7	1/2 x .55	0.31	
				5200	1670	345.0	4.0oz	1/2 x 1.92	1/2 x .75	0.37	
				7600	2640	545.0	6.5oz	1/2 x 2.1	1/2 x .85	0.41	
				9500	3510	725.0	8.5oz	1/2 x 2.2	1/2 x .85	0.43	
				3500	1310	271	3.25oz	3/4 x 2.4	3/4 x .75	1.0	
	3/4 x 3/4	—	5.0	5000	2000	411	5.0oz	3/4 x 2.5	3/4 x .75	1.0	
				6300	2630	544	6.5oz	3/4 x 2.6	3/4 x .75	1.05	
				7600	3280	678	8.0oz	3/4 x 2.7	3/4 x .85	1.1	
				14000	7000	1445	1LB 1oz	3/4 x 3.0	3/4 x 1.0	1.25	
				3800	1760	364	4.25oz	1 x 3.0	1 x .75	2.1	
				4800	2310	478	5.5oz	1 x 3.0	1 x .75	2.1	
1x1	—	10.0	5700	2800	580	6.75oz	1 x 3.1	1 x .75	2.2		
			11000	6130	1270	15.0oz	1 x 3.5	1 x 1.0	2.5		
			18000	11000	2280	1LB 10oz	1 x 3.8	1 x 1.1	2.75		
			8900	7700	1590	1LB 3oz	2 x 5.5	2 x 1.0	14.5		
			1600	460	46	2.2oz	1/2 x 1.6	1/2 x 0.63	0.31		
			2300	700	72	3.5oz	1/2 x 1.75	1/2 x 0.70	0.35		
	3/4 x 3/4	—	5.0	5200	1950	200	9.5oz	1/2 x 2.10	1/2 x 0.95	0.43	
				1500	540	56	2.7oz	3/4 x 2.10	3/4 x 0.63	0.87	
				3500	1470	151	7.2oz	3/4 x 2.5	3/4 x 0.80	1.05	
				5000	2250	230	11.0oz	3/4 x 2.6	3/4 x 0.95	1.12	
				2600	1250	130	6.1oz	1 x 2.8	1 x 0.75	2.0	
				3800	1940	200	9.5oz	1 x 3.0	1 x 0.85	2.2	
1x1	—	10.0	4800	2550	260	12.5oz	1 x 3.1	1 x 0.90	2.25		
			1900	1500	160	7.5oz	2 x 4.66	2 x 0.60	11.5		
			2400	1900	200	9.5oz	2 x 4.75	2 x 0.66	12.3		
			2900	2400	250	11.5oz	2 x 4.85	2 x 0.75	12.5		
			5300	4600	480	1LB 6.5oz	2 x 5.50	2 x 0.95	14.0		
			8900	8300	860	2LB 8 oz	2 x 5.90	2 x 1.15	16.0		
	0.25	1/2 x 1/2	—	0.5	1600	550	22.5	7oz	1/2 x 2	1/2 x .85	0.40
					3200	1350	55	1LB 1oz	1/2 x 2.5	1/2 x 1.10	0.50
					1000	390	16	5oz	3/4 x 2.3	3/4 x 0.71	0.98
					1500	640	26	8oz	3/4 x 2.5	3/4 x 0.83	1.05
					1100	530	22	6.5oz	1 x 2.9	1 x 0.75	2.10
					3700	2260	92	1LB 12oz	1 x 3.6	1 x 1.20	2.7
3/4 x 3/4		—	5.0	1300	1050	43	13oz	2 x 4.9	2 x 0.80	12.7	
				2000	1750	71	1LB 6oz	2 x 5.2	2 x 1.0	13.8	
				3300	3060	125	2LB 6oz	2 x 5.5	2 x 1.1	14.7	
				4000	3820	156	2LB 15oz	2 x 5.6	2 x 1.2	15.2	
				1300	1510	62	1LB 3oz	3 x 6.9	3 x 0.8	39	
				1600	1900	77	1LB 7oz	3 x 7.0	3 x 0.85	40	
0.50	1/2 x 1/2	—	0.5	3200	1700	35	2LB 10oz	1/2 x 3	1/2 x 1.45	0.62	
				1480	735	15	1LB 2oz	3/4 x 2.9	3/4 x 1.1	1.26	
				3000	1800	37	2LB 13oz	3/4 x 3.5	3/4 x 1.5	1.6	
				800	410	8.5	0LB 10oz	1 x 3.0	1 x 0.85	2.2	
				1600	945	19	1LB 8oz	1 x 3.5	1 x 1.0	2.5	
				7800	7000	143	10LB 14oz	1 x 5.2	1 x 2.2	4.2	
	3/4 x 3/4	—	5.0	1800	1700	35	2LB 10oz	2 x 4.9	2 x 0.75	12.7	
				3800	4100	83	6LB 6oz	2 x 5.5	2 x 1.15	15.0	
				860	1000	21	1LB 10oz	2 x 6.2	2 x 1.5	17.3	
				1840	2350	48	3LB 10oz	3 x 7.1	3 x 0.85	40.0	
				2620	3500	71	5LB 7oz	3 x 7.5	3 x 1.15	43.5	
				3500	4850	99	7LB 8oz	3 x 8.1	3 x 1.5	48.0	
1x1	—	10.0	8700	14000	282	21LB 8oz	3 x 9.3	4 x 2.3	58.0		
			5000	6600	270	5LB 2oz	3 x 7.8	3 x 1.35	46		
			8400	12000	485	9LB 3oz	3 x 8.3	3 x 1.65	50		
			3200	1700	35	2LB 10oz	1/2 x 3	1/2 x 1.45	0.62		
			1480	735	15	1LB 2oz	3/4 x 2.9	3/4 x 1.1	1.26		
			3000	1800	37	2LB 13oz	3/4 x 3.5	3/4 x 1.5	1.6		

Fig. Q-171. Construction data for Impedance units between the limits of 0.5- and 100 hy.

Announcing The Pre-Publication Offer of the

1933 Official Radio Service Manual

The importance of the last two OFFICIAL RADIO SERVICE MANUALS to those engaged in the Radio Industry has been shown by the fact that over 52,000 copies of both editions have been purchased and are in use by manufacturers, jobbers, dealers, Service Men and experimenters. Incessant demands have encouraged us to publish a new and bigger *Service Manual* for 1933.

The new manual will not contain so many full-page illustrations as in the past for the reason that not as many new sets are being put out at present, but will have in its contents important information that has not yet appeared in print. This new "dope" is invaluable to radio men. Stress has been emphasized on giving only practical material, not complicated theory. It is bound to save time and money for everyone.

The simplicity in the makeup of the 1933 Manual makes information easy to find, accurately and quickly. As in the past the size will be 9 x 12 inches, with flexible, looseleaf leatherette cover.

Many additional features will be included in the new manual. The FREE QUESTION AND ANSWER SERVICE which was extremely popular in the previous edition will also be maintained. We assure you that the 1933 OFFICIAL RADIO SERVICE MANUAL will be a revelation in radio literature.

Advanced orders are now being accepted at a most attractive pre-publication price of \$4.00. Immediately upon publication of the new *Manual* this price shall be withdrawn and the Five Dollar sales price shall prevail. Take advantage of this low price—send your order today. Be among the early ones to get a copy from the first printing. Checks or money orders accepted—register letter if it contains cash or unused U. S. Postage Stamps.

The following are partial contents of the 1933 Manual:

Complete operating notes, and hints from actual experience with radio receivers in the field, collected by practical Service Men all over the country.

Complete actual, pictorial views of hundreds of commercial receivers with additional schematic diagrams. Location of parts on the chassis are shown, and where important adjustments must be made. This section alone is worth the price of the book.

Values of all intermediate frequencies used in superheterodynes, and a complete section of valuable service data on superheterodynes.

Values of resistors and condensers, to aid in replacement work.

Latest information on combination long- and short-wave receivers, short-wave adapters and converters.

How to tune and service short-wave receivers for best results.

How to use the most modern servicing instruments.

Complete section showing how the Service Man can build himself service instruments, oscillators, etc., at very low cost.

Complete section on the construction of all test equipment, including high- and low-frequency oscillators, tube checkers, ohmmeters, etc.

Tube-chart information on all new and old tubes, in handy form for quick reference; indicating socket connections and operating values, thereby preventing confusion.

An entire section on money-making suggestions for Service Men, written by the Service Men themselves who have made a success of the business; giving you short cuts and commercial information on how to get the most out of the servicing game.

Servicing information on interference elimination, with practical data and many examples of interference prevention.

Automobile radio installation and servicing—hints on automobile radio in general.

Complete data on servicing all known, commercial, automobile receivers with short cuts to get quickly at the seat of the trouble.

Service kinks, servicing short cuts, and miscellaneous servicing information.

A complete section of various radio tables of every imaginable kind, in constant use by up-to-date Service Men.

A large section giving complete technical data on meters of every kind pertaining to servicing in general.

Complete index and cross-index to make it easy for you to find almost anything pertaining to service *instantly*.

FREE
QUESTION
AND
ANSWER
SERVICE

In every copy of the 1933 Manual, 24 coupons will be found, which will entitle you to 24 thorough and complete answers by mail on servicing and operating on any of the sets or circuits mentioned in the manual, as well as any others not mentioned, for which you might have need. This service alone is worth \$6.00. But it is absolutely free to manual owners.

\$4.00

THIS SPECIAL
OFFER IS VOID
AFTER
SEPTEMBER 10th

OVER 2,000
ILLUSTRATIONS

OVER 700 PAGES

9 x 12 INCHES

FLEXIBLE
LOOSELEAF
LEATHERETTE
COVER

GERNSBACK PUBLICATIONS, Inc.
96-98 Park Place, New York, N. Y.

I am enclosing herewith my remittance of \$4.00 for which you are to send me one copy of the 1933 OFFICIAL RADIO SERVICE MANUAL at the special pre-publication price of \$4.00 each. I understand that the price of the 1933 Manual will be Five Dollars upon publication, when this offer will be void. This offer is void after September 10th.

Name

Address

City..... State..... RC-932

THE OFFICIAL RADIO SERVICE MANUAL
FOR 1933 COMES TO YOU COMPLETE
THIS YEAR—NO SUPPLEMENTS
MAIL COUPON NOW

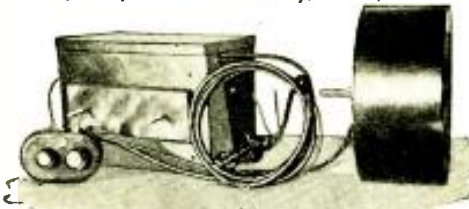
<p>Write Today for Information on This</p>	<p>AUTO-DIAL RADIO Quality, tone, selectivity, and power</p>  <p>COMPLETE \$39.20—includes set, remote control, suppressor kit, tubes and dynamic speaker. Set only \$17.65. Dealers wanted. Write today. J-M-P MANUFACTURING CO., INC. 3357 Fond du Lac Ave., Milwaukee, Wis.</p>	<p>Sensational AUTO RADIO</p>
--	--	--

Mr. SERVICE MAN

Thank You — Our advertisement in the August issue brought us hundreds of replies,

and NOW hundreds of copies of "GOLD SEAL Radio Tube Sales Plans for the Service Man" are on the way. Step to GOLD SEAL Radio Tubes and Profits!

The tubes you need—for receivers, transmitters, public address or television are made by GOLD SEAL.

GOLD SEAL Sales Engineers have developed a special "Selling Plan" for the Service Man. It's yours in return for the coupon.

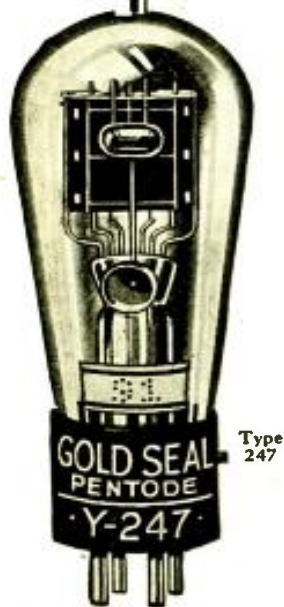

Newly Made
Fully Guaranteed
Long, Useful Life
Licensed by RCA
And Double Tested
An Experienced Staff
Standard Specifications
Best of Materials Used
New and Modern Equipment

**STEPS TO GOLD SEAL
RADIO TUBES**

Mail Coupon TODAY!

GOLD SEAL MFG. COMPANY
5 Central Ave., East Newark, N. J.

Please send me by return mail Specifications on GOLD SEAL Radio Tubes and your "Sales Plan" for Service Men.

Name _____

Address _____

City _____ State _____

OVER-THE-COUNTER SUGGESTIONS

By JACK GRAND

In this department Mr. Grand passes on to RADIO-CRAFT readers many new thoughts and ideas he encounters in his daily over-the-counter contact with radio technicians who come from all over the world to one of New York's oldest retail radio establishments.

IT IS common practice among Service Men in testing mica and paper condensers (only) to use a low potential of about 4½ volts. Many of these condensers will show very different results when a potential of 100 volts is used.

Often, in small midget and console sets using four or five tubes, it is found that the voltage is not very steady although the line voltage appears to be constant. A change of the voltage divider to one of a lower resistance value will usually correct this condition.

It is good practice for a Service Man to recommend a new type of tube to replace older and less efficient types. In cases where the type 56 tubes are recommended in place of the '27, a little difficulty may be experienced where four or more of the former replace the latter on a given filament winding; especially is this true on transformers with poor voltage regulation. The filament of the type '27 tube is rated at 1.75 amperes and the type 56 at 1. ampere, the difference being .75-ampere for each tube. On four tubes, the current difference reaches the total of 3 amperes. Such a large difference in current will cause a rise in voltage which will be harmful. To prolong the life of the type 56 tubes in such cases a suitable resistance should be placed across the filament winding, as illustrated in Fig. 1; the shunt resistor is Rs. The value of the resistance is dependent on the number of tubes, i.e., 2.5 volts, divided by .75 times the number of tubes to be used gives the figure for the required resistance value. Do not use a series resistor in this type of circuit.

In many of the old sets where type '71A tubes were used to replace the type '71 tubes, it was found that the '71A's would not last very long. The use of a 20-ohm resistor connected in shunt to the filament of a single '71A; or a 10-ohm unit shunting the filaments of type '71A's in push-pull, will prolong the life of these tubes.

Fast-heating tubes in the R.F. stages and a slow-heating tube in the detector will cause a howl in sensitive sets.

Several radio set manufacturers are now using two reproducers in their better models; one unit is pitched low and the other high. A good dynamic reproducer with a large cone surface is used as the former; and for the latter, a permanent-magnet dynamic unit with a small cone surface. The permanent-magnet speaker does not require any energizing current, therefore, it is easily installed. This method of getting better tone should be more satisfactory and much more profitable than the use of a tone control.

It is surprising to note the amount of "static" that can be traced to the cheap variety of resistors and electrolytic condensers that are now flooding the market.

A wattmeter is one useful instrument that the average Service Man does not own. Voltage regulators can be installed at a decent profit and certainly with a wattmeter it is not difficult to determine the correct regulator for the radio set under test.

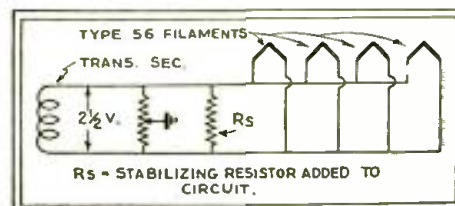

Fig. 1
Circuit showing the location of a suitable resistor.

A NEW LAPEL MICROPHONE

(Continued from page 141)

search and practical experimentation. Around the carbon button is placed a felt ring. This felt ring, as shown in the schematic section view of Fig. 1, fills out the space between the button of the microphone container and the membrane. The whole space inside this ring, which is terminated at one end by the diaphragm and at the other by the carbon button, is filled with carbon grains. The felt washer must be high enough so that no carbon can fall out between the diaphragm and the washer. However, it must not be too high, as otherwise the membrane will be considerably damped by the contact with the felt washer. There is one and only one definite height at which it works best.

The Romance of Microphone Carbon

The space inside the felt ring and between the button and diaphragm is filled with carbon grains. These carbon grains, in connection with the other acoustical details of the microphone, are one of the secrets of its performance. Though it is easy to say that the space has to be filled with carbon, it is a more difficult proposition to select the appropriate material.

It is necessary to know the history of the geological and paleontological development of our earth for finding the proper carbon. The hardest and cleanest carbon must be used exclusively, for this purpose, and this carbon can be found only in very few of the mines of the world. Millions of years ago, this carbon stood in the form of trees in prehistoric forests. There are, however, only two or three species of trees of this period that give good carbon for microphones and then only if these trees happened to be submerged for millions of years at the lowest points of the mine, so that they have been submitted to a terrific pressure over a long period.

This depends again upon movements in the earth's crust. Only this type of carbon is selected, taken out, ground, washed, heated in a vacuum to eliminate the volatile substances, thereafter treated in acetone and xylol to remove greasy impurities which tend to reduce the conductive properties of the surface, polished in a certain way, and then measured. The size of the carbon determines its acoustical action together with its surface properties.

How great the differences between various carbons are, will be realized when comparing Figs. 2A and 2B which show two different species of carbon.

Only the carbon which will give the desired acoustical properties, the proper electrical re-

sistance, the necessary volume, the equilibrium of the high and low tones, and many more points which have to be taken into consideration by the acoustical engineer, is selected.

The next step is the construction of the membrane. A very thin membrane is stretched over the container. As sound waves strike this membrane, it oscillates in step with them, and these oscillations exert a pressure upon the carbon grains which fill the space between diaphragm and button. If the carbon is pressed, its electrical resistance is lowered. We have here, therefore, a means of controlling electrical currents by acoustical impulses. These impulses will be reproduced better, the more elastic and therefore the thinner the membrane. On the other hand, a thin membrane, like copper, will change its elastic properties quickly if it is stretched. Only special materials with a high nodal of elasticity can be used.

In the case of the lapel microphone shown, a new gold-plated alloy has been used for this purpose which makes possible high elasticity and constancy in action over, practically, an unlimited period of time.

There are two more points to be taken into consideration in building this highly efficient microphone. These are the air spaces over and below the membrane, and the amount of electrical current passing through the microphone. Naturally, as a membrane is used which has a thickness of only from one to two thousandths of an inch, approximately, a protective cover must be provided. This cover builds a sort of resonant system that produces an air space of definite dimensions between itself and the membrane. It is therefore necessary to observe the exact distance between the cover and membrane within close limits, and to treat this cover acoustically in a special way.

Electrical Characteristics of the Microphone

Of highest importance in the action of the microphone are its electro-acoustical characteristics. Every part of the "mike" must be tuned with regard to the entire system. Only the sum total of these elements determines how the primary acoustical impulses, converted into electrical oscillations, will finally be impressed upon the amplifying system with which the designer of the amplifying equipment must deal.

A second article will follow dealing with the sound-control and amplifier of this new public address system.

STILL MORE NEW TUBES

(Continued from page 144)

is lower than that of an ordinary tetrode normally employed as a second detector and for this reason. It is desirable to employ a low impedance input circuit or coupling device. This may be readily accomplished by taking the usual I.F. transformer, connecting two coils together and only tuning the secondary.

As will be appreciated at this time, this tube is mainly suitable for use as a second detector in superheterodynes. Fig. 7B and 7C show the circuit arrangement when feeding into a push-pull or push-push audio stage and when using this tube in an A.V.C. arrangement. The following characteristics obtain: Heater voltage, 2.5 for the 29 and 6.3 for the 69; filament current, 1-ampere for the 29 and 3-ampere for the 69. The following data obtain for either tube: Plate voltage, 180; plate current, 4.5 ma.; grid voltage, -3; amplification factor, 30; plate resistance, 20,700 ohms; mutual conductance, 1,450 micromhos.

It will be especially interesting to notice the use to which these rather new tubes will be put.

The 257

A new tube bearing the designation TS-257 for use in D.C. power-operated receivers has recently been announced. This new tube is intended for use in the power-output stage of 115-volt D.C. operated sets especially designed

for it. It is shown in Fig. F. Since the filament-current rating of this tube is the same as the 36, 37, 38, 39, that is, 300 ma., any filament combination of these tubes is practical, provided the current is adjusted to its rated value at normal line voltages. It is recommended that the load impedance be maintained fairly constant at 6,000 ohms with the plate voltage of 110 volts. However, due to a voltage drop in the output transformer, the actual voltage at the plate will be somewhat lower and the load impedance giving maximum distortion will then be about 4,500 to 5,500 ohms depending, of course, upon the resistance of the output transformer. Fig. 8 is the suggested arrangement for a push-pull output stage in a receiver operating from 115-volt power line. A standard 22½-volt "C" battery is used for supplying the grid biases for the two TS-257's. The following ratings and characteristics obtain: Filament current, 3 amperes; plate voltage, 110; screen-grid voltage, 110; control-grid voltage, -21.5; amplification factor, 55; internal impedance, 41,000 ohms; mutual conductance, 1,350 micromhos; plate current, 20 milliamperes; screen-grid current, 6.6 ma.; power output 800 milliwatts. Fig. 9 shows the relation between total power output and load resistance, and harmonic output and load resistance. In Fig. 10, the dynamic characteristics are shown.

"Elected!" to make RADIO HISTORY in 1932-33

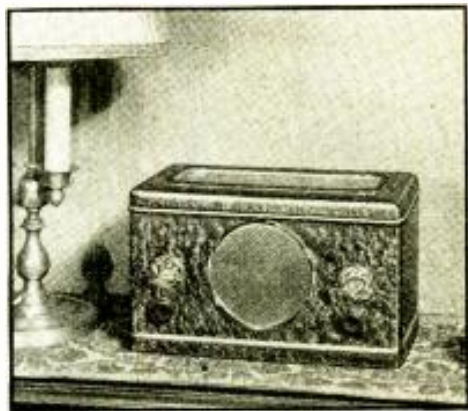

The NEW Crosley PUP

This 4-tube superheterodyne housed in a beautiful silver-gray metal cabinet is a radio marvel. It incorporates balanced image suppressor pre-selector—combined volume control and on-off switch—illuminated station selector—dynamic speaker and other outstanding features. Dimensions: 7½" high, 12½" wide, 7" deep. **\$2600** Complete with Tubes Tax Paid

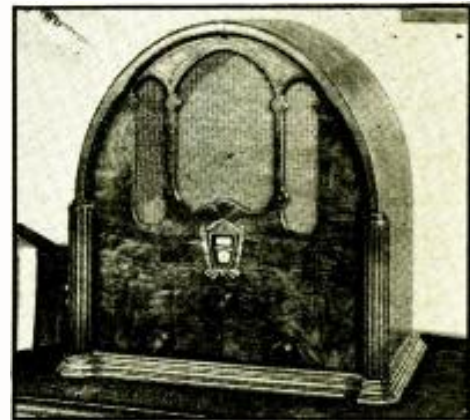

The Crosley MAYOR

Here is the leader of the famous Crosley "Election" Series. This 9-tube superheterodyne incorporates 2½-volt heater type tubes—four gang tuning condenser—double tuned image suppressor pre-selector—silent automatic volume control—meter tuning—continuous (stepless) tone and static control—illuminated hairline shadow dial with vernier drive—manual audio level control. Dynamic speaker is used. **\$5250** Complete with Tubes Tax Paid

Western Prices Slightly Higher

THE CROSLLEY RADIO CORPORATION
Powel Crosley, Jr., President
Home of "the Nation's Station"—WLW
CINCINNATI

YOU'RE THERE WITH A CROSLLEY
**CROSLLEY
RADIO**

CONCOURSE

(DRY)

Electrolytic Condensers

Save Time and Profit for
Service Men

An established condenser with a solid reputation for performance. Working voltage 450, peak voltage 600. 20% more capacity than rated; very low power factor. Replaces cumbersome paper blocks in a jiffy. Easier servicing; more profit for you; customer satisfaction assured. Types for every specification. Get the complete story at once—there's money in these Condensers for YOU!

WRITE OR WIRE FOR
OUR COMPLETE
DESCRIPTIVE CATALOGUE.

CONCOURSE
ELECTRIC COMPANY

389-409 WALES AVE., N. Y. C.



A good name
NA-ALD
in radio

Send stamps for charts showing
adapters to use with different makes
of testing equipment for testing all
the new tubes, including 55-85-57-58-
82-G-2-41-421 Wunderlich and the new
seven prong tubes.

ALDEN MFG. COMPANY
BROCKTON Dept. R. MASS.

G.E. PHONOGRAPH MOTOR



Synchronous 110 Volt,
60 Cycle, 80 R.P.M.

Only
\$3.95
1/20
VALUE

Can be installed in
place of old fashioned
hand winding spring
motors. Also many other uses. These
G. E. motors are all brand new in original
factory cartons. Fully guaranteed \$12.00 value only
\$3.95. Shipped Prepaid. Manufacturers and dealers
write for Special quantity price.

NATIONAL ELECTRIC TOOL CO.
111 W. Lake St. Dept. 179 Chicago, Ill.

\$5,000 WILL BE PAID TO ANYONE WHO PROVES THAT THIS IS NOT THE ACTUAL PHOTO OF MYSELF SHOWING MY SUPERB PHYSIQUE AND HOW THE ROSS SYSTEM HAS INCREASED MY OWN HEIGHT TO 6 FT. 3 3/4 INCHES. HUNDREDS OF TESTIMONIALS. CLIENTS UP TO 45 YEARS OLD GAIN FROM 1 TO 6 INCHES IN A FEW WEEKS!

No Appliances—No Drugs—No Dieting. ROSS SYSTEM NEVER FAILS. Fee Ten Dollars Complete. Concise Testimony and Particulars 6 cent stamp. Allow time for return mails across the Atlantic. G. MALCOLM ROSS, Height Specialist, Scarborough, England. (P. O. Box 15).

First in 1907
First To-day

the Atlantic. G. MALCOLM ROSS, Height Specialist, Scarborough, England. (P. O. Box 15).

AERO SHORT WAVE RECEIVER..... \$ 6.45
AERO AUTO RADIO, Complete..... 39.50
AERO SHORT WAVE CONVERTER..... 12.50

Send for Complete Catalog
CHARLES HOODWIN CO.
Dept. W-15
4240 Lincoln Ave. Chicago, Ill.

◆ BOOK REVIEW ◆ SOUND PICTURES AND PUBLIC ADDRESS SYSTEMS

1 P.A. *Power supplies for Power Audio Amplifiers*—The first book of the National Radio Institute series on sound pictures and public address systems deals with various types of power supply units for the voice amplifiers used in public address systems. It covers special rectifier systems for A.C. operation, and also motor generator sets. It contains numerous schematic diagrams and much useful service data that the practical sound Service Man will be able to use.

2 P.A. *Pickup Devices; Speech Input Analysis*—Theory and operation of the various types of microphones used in public address systems are studied in this lesson, which also includes a description of the standard input systems. The carbon button, condenser and ribbon microphones are described in understandable language and the details of their construction are illustrated. The characteristics of phonograph pickups are also given considerable space. The last section explains how sound level in audio amplifier systems is figured.

3 P.A. *Impedance Matching Networks, Pads and Volume Controls*—With this booklet the course becomes more advanced and technical. The importance and necessity of proper matching of input and output impedances in relation to the line is emphasized and the methods of figuring the proper values are given. The many special forms of volume controls and faders used in P.A. work are thoroughly described.

4 P.A. *Transmission Lines; Volume Indicators; Monitors*—This book is a study of long distance telephone lines in connection with their application to radio pickups. It deals with such questions as repeaters, transmission levels, power level indicators and transmission efficiency. It also includes a study of monitoring, which is the process of controlling the energy level in a transmission system, or of varying the relative levels from each of the number of systems fading into a single transmission unit.

5 P.A. *Acoustics of Building*—Every radio man who has had occasion to install receivers or amplifiers in public places knows of the troubles produced by unfavorable acoustics. This book is a detailed study of the special qualities of various kinds of buildings as applied to talking motion picture and P.A. systems. It includes some valuable information as to how the reverberation of a room or auditorium may be adjusted to suit individual conditions. The problem of sound proofing studios is also considered.

6 P.A. *Outdoor P.A. Systems*—The many uses of P.A. systems are considered here from the standpoint of the layout microphones, loud-speaker placement, electrical pickup, power supply, monitoring, etc. The reader is par-

—VAN—

SHUNTS-DIALS RESISTORS

For small 1 Milliampere Meters,
A.C. or D.C. Rectifier Type
COMPACTNESS — STABILITY
QUALITY

ORDER THROUGH YOUR DEALERS
If they cannot supply, send for folder.

D. L. VAN LEUVEN—Laboratory
410 East 15th St. New York City

PUBLIC ADDRESS SYSTEMS

and sound amplification applications should be part of your radio knowledge. Modern equipment at resident schools in N. Y. and Chicago, or home study with new "no obligation" plan. Write for illustrated book.

RCA INSTITUTES, Inc.
Dept. RT-92
75 Varick Street, N. Y. C.



RADIO+

A Host of Other Interesting
Scientific Subjects—

TELEVISION
ELECTRICITY
PHOTOGRAPHY
AVIATION
WOODWORKING
AUTOMOBILES
PATENTS AND
INVENTIONS
NEW DEVICES

CONSTRUCTION
METAL WORKING
PHYSICS
ENGINEERING
METALLURGY
PUBLIC ADDRESS AND
SOUND EQUIPMENT
HOUSEHOLD AND
SHOP HINTS
AND OTHERS

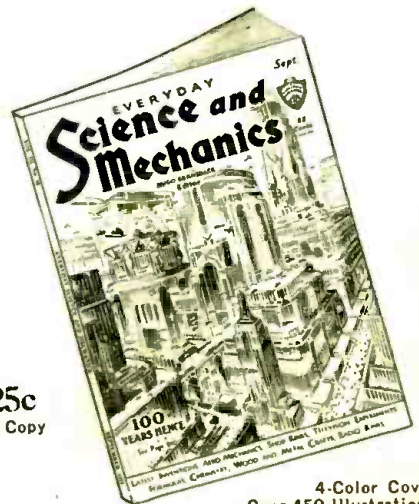

25c
The Copy

4-Color Cover
Over 450 Illustrations
96 Pages—9x12 inches

MR. HUGO GERNSBACK'S latest magazine contains the most important and recent developments in Science, Mechanics, Radio, Television, Aviation and Chemistry. For everyone, regardless of age, EVERYDAY SCIENCE AND MECHANICS will be found to be useful and instructive. Thoroughly illustrated with scientific events from all parts of the world, and helpful to thousands of high school, university students and instructors who wish to advance their scientific knowledge.

Many excellent pages for the home workshop man who finds pleasure in building things; experiments in electricity, chemistry and formulas of all kinds.

SPECIAL OFFER!

8 Months for \$1.00

Clip Coupon Now and Mail!

EVERYDAY SCIENCE AND MECHANICS
100 Park Place, New York, N. Y. RC-9

I enclose herewith One Dollar for which you are to enter my subscription to EVERYDAY SCIENCE AND MECHANICS for the next Eight Months.

Name

Address

City..... State.....

A HIGH-GAIN T. R. F. RECEIVER

(Continued from page 149)

expansion bit can be used to make these holes. Place a piece of hard wood under the aluminum and drill a small hole in the aluminum where the center of the socket hole is to be. Now use the expansion bit; the lead screw will get a hold in the wood; work from each side. The $\frac{3}{4}$ -inch holes may be made in the same manner. The dimensions of the socket mounting holes are not shown as the sockets vary with make. There are several holes marked "T"; this means tap with a No. 6-32 tap. Two holes are shown on the right at the back without dimensions; the one for the ground terminal is for a No. 6 screw and the other is for the insulating bushing on the antenna post. All other holes not marked for size are to be made with a No. 25 drill.

Four dotted lines intersecting at the corner cutouts show where the bends are to be made. Use two pieces of hard wood with square edges, clamp these to the aluminum with two strong clamps so that the line is just flush with the wood block. The job can now be fastened down on the edge of the work bench and the bending done with a hammer and block of wood. Be careful to bend the front and back so that they are square with the top surface. The ends are only to stiffen the chassis.

Mounting the Parts

Two views of the chassis assembly are shown, one of the top, Fig. B and the other showing the positions of the various parts mounted on the under side, Fig. C. Start the assembly by attaching all the tube sockets and then the bypass condensers. Mount the large filter choke in the corner, the power transformer and the four electrolytic filter condensers; their position with respect to capacity is shown in the top view. Next, mount the input transformer just back of the last '27 socket. The output transformer is fastened to the top of the chassis with the same screws used to hold the second filter choke on the under side. Since, in some places, the screws in the tapped holes are under another piece of apparatus, these screws should not be long enough to project above the surface.

Use care in mounting the tuning condenser as it must be fastened without strain. Use a small round file where the holes are a little off. As the three '35 tubes are to be shielded, the shield bases should be put on with the sockets. With the exception of the large divider resistor, the smaller ones are left off until the wiring is being done, as they are of the pigtail type and are all soldered to the terminals. Attach the power switch and the variable resistor to the front of the chassis as shown, also the antenna and ground posts. Use insulating washers on the antenna post.

Putting the chassis aside, several detail parts must now be made. In Fig. 3A, a bracket to be made of aluminum is shown, this is used to hold the antenna-system coils to the underside of the chassis. The bracket B is made of the same material and its use will be explained presently. Make two items as shown in Fig. 3C, as these supports are used to hold the long, power resistor in place. A length of threaded rod is passed through the center of the resistor and the supports are held with a nut at each end. The strip shown in Fig. 3D is to be made from hard rubber, $\frac{1}{8}$ -inch thick; it supports the two tip jacks for connecting the output to the voice coil on the speaker. This rubber strip is fastened to the inside of the rear foot of the chassis.

The main resistor has two sliding taps. For the present, one of these is placed two inches from one end and the other, one inch from the other end. In wiring, connect the one-inch end to the choke.

Coil Construction

Figures 4A, B and C show the coil forms with the windings. It is not, as many will try to prove, an impossible job to make up a set of coils, each one like the other with respect to inductance. First make up five forms as shown in Fig. 5. One-inch diameter tubing with a 1/16-inch wall is to be used for these forms. The bracket shown riveted to one end

of this is made from a wide strip of aluminum or brass, $\frac{3}{4}$ -inch wide. Drill four other holes around the edge of the tube and insert eyelets of brass to be used as soldering terminals. It will be noted that coils in Figs. 4B and C each have a 147-turn winding of No. 32 B&S enameled wire. Three coils exactly like the coil Fig. 4C are needed so we will wind this 147-turn winding on four coil forms. The winding properly done will cover $1\frac{1}{2}$ inches on the form. A small hole at each end will serve to anchor the wire. Wind each one exactly alike. Now, for the fifth coil, Fig. 4A. On this form, wind 143 turns. On one of the five forms wind the 7-turn winding as shown in Fig. 4B.

Next wrap a strip of insulating cambric $\frac{3}{8}$ -inch wide around the winding on the four other coils. This is placed over the wire at the end furthest from the soldering eyelets. Taking the 143-turn coil first, wind the 15 turns of No. 26 enameled wire over the cambric. And by the way, this wrapping of cambric should be just less than 1.16-inch thick. Shellac or insulating varnish is applied to this winding and when it dries the turns will remain in place. This coil should now be marked No. 1. For the three coils in Figure 4C, use fine wire, No. 34 or smaller, for the 50-turn windings. Use varnish to hold these in place.

Cut 9-inch lengths of the various colored hookup wires. Then, when the coils are dry; carefully remove the enamel and solder the coil ends just as shown in the diagrams of Fig. 4 and attach the proper colored lead to each eyelet at the same time. Do this operation very carefully so as to avoid trouble later on.

Shielding the Coils

When a shield is placed on a coil, the inductance of the coil is lowered. The amount of drop will vary with shields of different dimensions, so if a coil of a specified number of turns is to have the intended inductance it must be shielded as calculated in the design. For this reason the coils described above must have shields 2 inches in diameter and be $3\frac{1}{2}$ inches high. See Fig. 6. The height may vary slightly but the diameter must be maintained, otherwise the coil will not tune with the condenser over the entire band. Drill five holes in the bottom of the shields to match those in the chassis and mount the coil by passing a 6-32 screw through the coil bracket, shield base and the chassis. Pass the four leads from the coil through the holes, the correct positions for the leads is clearly shown in the bottom view at the left where the coil leads are identified by color.

Coil Nos. 1 and 2 are mounted on the bracket on Fig. 5. If the proper care was taken in attaching the colored leads to the windings, the connections shown can be followed as regards color of leads.

The two leak mountings are next screwed to the side of the bracket, and this bracket, in turn fastened to the chassis between the two '27 sockets.

Wiring the Receiver

The heater wires should be wired first. There are five tubes connected to one winding so the leads must be heavy, No. 12 at least. Twist these two wires together and wire from transformer to first tube then to second tube and so on, all in parallel. The terminals on both the transformer and the sockets are marked Y. The '45 sockets are connected in the same way and these terminals are marked X. The wires are not drawn in as they would make the diagram more difficult to follow. Each of the R.F. coils on top of the chassis has one red wire. This is the grid wire and they are connected to the tuning condenser sections of corresponding numbers shown in the top assembly view.

To do this, they pass up through the proper holes in the chassis. Now before soldering these connections, slip a length of braided shielding over the leads or, of course, shielded wire may be used. The other two red leads from the coils under the chassis are also shielded; all, of these wire shields

New... A Weston Single Meter ANALYZER

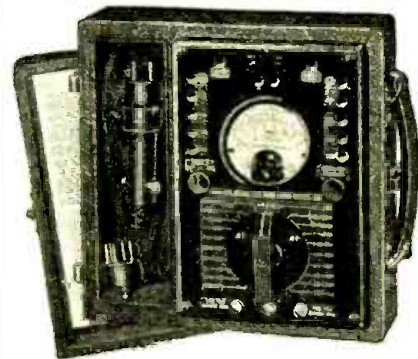

Weston Model 660

Every necessary socket voltage and current measurement, both A.C. and D.C., can be made on all modern receivers with this remarkable Weston Single Meter Analyzer.

Point-to-point tests are provided for with three resistance and ample voltage and current measuring ranges, available at pin-jacks on the panel. Full description is contained in the new Weston-Jewell catalog.

Pattern 675 Tube-Checker



A new, low-priced instrument that checks all present types of tubes without the use of adapters. Sixteen tube sockets are ingeniously arranged to occupy small space. Test limits

for all tubes are etched on the instrument panel. Compact and light in weight, this tube checker is popular for counter and portable use. Write for the Weston-Jewell catalog describing this great instrument value!

WESTON JEWELL



WESTON ELECTRICAL INSTRUMENT CORP.
JEWELL ELECTRICAL INSTRUMENT CO.
599 Frelinghuysen Ave., Newark, N. J.

Please send me a copy of your new catalog listing the complete Weston-Jewell line of radio instruments.

Name
Address
City State.....

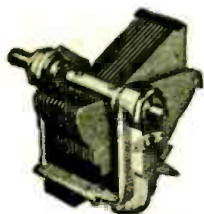

To Tune The MEGADYNE Receiver

A condenser is just a condenser to some set builders, but when results must be certain, it is safest to choose the Hammarlund specified by the circuit designer. Write Hammarlund Mfg. Co., 424 W. 33rd St., New York, for folder.

For Better Radio
Hammarlund
PRECISION
PRODUCTS

SERVICEMEN-DEALERS

Get Our Prices First
Complete Stock of NEW
Condenser Blocks
Volume Controls

Resistors
and Radio Replacement Parts
Write for our Catalogue

Hard to Get Parts—We have them. Send us your repair work for estimate.

Grant Radio Laboratories

6521-C South Halsted St., Chicago, Ill.

TUBE CHECKER

Oscillator and Short tester can be built using our Model 3 1, 1½, 2, 2½, 3, 5, 6, 7½ volt transformer. Tests all old and new tubes including C-57 C-58 etc. Full instructions included. \$2.65. Model 4 transformer same as shown in "Meterless Tube-Checker," \$3.65. Can supply other parts.



Adapter, 6 prong to 5 prong wired for testing C-57, C-58, 75 cents. 8 Point Tap Switch. Breaks between contacts. \$9 cents. All above shipped postpaid.
L & L ELECTRIC CO.
336 Madison Avenue Memphis, Tenn.

DICTIONARY

Travel along to music and song with the new DICTATOR Auto Radio. Employs seven tubes, including latest designed Eveready "LA" pentode auto radio tubes. Finest remote control device and Automatic Volume Control. The DICTATOR covers a wide broadcasting area with unusual selectivity and marvelous tone quality. Easily and quickly installed or removed. Set includes tubes, dynamic speaker, suppresor kit and remote control. Price complete, \$36.50. Dealers and Agents Wanted. Write Today.

AUTOCRAT RADIO COMPANY
3855 No. Hamilton Ave. Dept. RC Chicago, Ill.

FREE! The RADOLEK CO

109 Canal Station
Chicago, Ill.

Our new 1932 Radio Serviceman's Wholesale Price Guide will be sent to you upon request. Write, using your letterhead or business card. Send for it today.

Knowledge Pays Big

We teach you how to build and operate Radio Treasure Finders and how to locate Metals Underground. Fascinating. Scientific. Accurate. Full details for 2c stamp—Write TODAY.
Exchange, P. O. Box 607-W El Monte, Calif.

SERVICE MEN

ELECTRAD RESISTOR HAND BOOK Need the permanent guide to resistor values in all receivers. Loose-leaf, DuPont FabriKoid cover, \$1. a year, with 4 supplements. At your dealer, or mailed direct. Money back if not satisfied.

Mail \$1.00 to Dept. RC-9

175 Varick St., New York, N.Y.
ELECTRAD

must be grounded by soldering a connection to the ground terminal on the chassis. These shielded wires are necessary to reduce the coupling between the R.F. stages, where the gain is very great. In making connections, refer to both the picture and the schematic diagrams, the first for point-to-point information and the latter for the part each connection plays in the circuits.

All blue coil-leads connect to the '35 plate terminals. The 10,000-ohm screen resistors for these same tubes are soldered to the socket terminals and the other ends are all connected to the first tap on the voltage divider resistor. In making the connections from the .00025 bypass condensers, do so directly to the socket terminals. By using stiff wires to the R.F. choke and its bypass condensers in the plate circuit of the detector, it will be self-supporting. The low side of these two condensers is connected to the detector cathode and not to the chassis as in other cases.

The plate of the detector feeds into the resistance coupled system consisting of a 25-megohm resistor and a 50,000-ohm resistor, as shown. The coupling condenser is mounted by the heavily soldered connections. The plate of the first-audio tube goes to the second tap on the divider through the primary of the audio input. The green leads from the three R.F. coils also go to this tap. The plate current for the '45 tubes is taken at the juncture between the two chokes. While the detector plate is fed from the end of the divider. This allows a high coupling resistor in the plate circuit. Finish up the wiring and check each connection for error.

Adjusting the Receiver

It is rather hard to foresee all of the difficulties that the constructor may encounter but in the following paragraphs as much help will be given as possible; with patience and effort all of these should be ironed out. First place only tested tubes in the receiver so that no trouble will result from poor tubes. Connect the aerial and ground and connect the power plug to the lighting circuit. With the switch on, the tubes should light up, wait a moment until they reach operating temperature. Now turn up the volume control and in all probability the set will oscillate; if it does not, move the screen-voltage tap for the '35 tubes to a higher point on the divider. If it still will not oscillate with 90 volts on the screens and the bias cut to a minimum with the control, look for wrong connections to the R.F. transformers. Once in an oscillating condition it gives proof that the connections are probably right.

But who wants an oscillating receiver? Now we must stop this racket; the volume control will do this by increasing the bias on the three '35 tubes. However, what is wanted is stable operation with minimum bias *without oscillation*. Next, lower the screen voltage to not less than 75 volts, using a high resistance voltmeter for making all measurements. Using the volume control to hold it just under the oscillating point, adjust the condenser trimmers. Tune in a station near one end of the range and adjust them for strongest signal. Now tune in a station near the other end of the scale. It may be necessary to again adjust these trimmers. By working back and forth they will be adjusted to the best advantage for the whole range of the receiver. If one stage requires a large change between points, the plates on the rotor may be bent to give more or less capacity near one end. The condenser used has a slotted plate on each rotor section for this purpose.

The coupling resistors in the detector output may cause some trouble, hence they are made removable. Ordinarily, a 1 meg. resistor is used in the grid but if the set motorboats reduce this. The greater the resistance, the more amplification will result. With the condensers trimmed for action let us get back to the bias again. The 100-ohm resistor in series with the variable one limits the minimum bias. If the receiver oscillates too easily move the last tap to a lower voltage on the divider resistor. However, not less than 180 volts should be applied. It may even be necessary to use a higher fixed resistor than 100 ohms to prevent the receiver from oscillating with the variable resistor cut out.

Due to the method of transferring energy from the first tuned circuit to the second, the set will be found to tune sharply and at the same time not lose volume by leaving out the side bands. As previously stated, the connections to the control grid caps of the '35 multi-tube are on top of the chassis. These three wires are clearly shown on the drawing of the top view and in the photographs and are soldered to the three middle tuning condenser sections. Make these wires only long enough to reach, as they will pick up powerful local signals if left long.

A panel will be seen in the photographs of the completed receiver. This can be made to suit the constructor's needs as cabinets are made with different sized openings. The drum condenser drive mechanism must also be fitted individually as these, too, differ in details of construction. The small pilot light will, in all cases, be connected to either of the 2.5 volt transformer windings.

List of Parts

- One Polymet power transformer, type TF-786, PT.1;
- One Polymet choke, type TC-793, CH.1;
- One Polymet choke, type TC-794, CH.2;
- One Polymet push-pull input transformer, type TA-731, A.F.1;
- One Polymet push-pull output transformer, type TA-734, T.1;
- Two Polymet electrolytic condensers, 4 mf. (500 volt), C1;
- Two Polymet electrolytic condensers, 8 mf. (500 volt), C2;
- Three Polymet bypass condensers (100 volt), type C-880, C3;
- One Polymet bypass condenser (mica), .01-mf., C4;
- Two Polymet condensers (mica), .0001-mf., C5;
- Three Polymet condensers (triple section), .25-mf., C6;
- One Polymer variable resistor (volume control), 2,000 ohms, type VC-1836, R2;
- One Polymet wire-wound resistor, 100 ohms, R3;
- Three Polymet pigtail resistors, 10,000 ohms (2 watt), R4;
- One Polymet pigtail resistor (1 watt) 60,000 ohms, R5;
- One Polymet pigtail resistor, 3,000 ohms (2 watt), R6;
- One Polymet pigtail resistor, 50,000 ohms (1 watt), R7;
- One Polymet 250,000-ohm resistor, R8;
- One Polymet 1 megohm resistor, R9;
- One Polymet wire wound resistor, 750 ohms (20 watt), R10;
- One Polymet center-tapped resistor, 10 ohm, R11;
- One Electrad variable resistor with two taps, 20,000 ohms, type D, RV;
- Five wafer-type UY sockets;
- Three wafer-type UX sockets;
- One Precise tuning condenser, type 500 .00035-mf., 5 gaug., C7;
- One Hammarlund Drum-type condenser drive mechanism;
- One power switch, SW;
- Four rolls of hook-up wire, red, blue, green and black;
- Three Blau aluminum shields;
- Five Blau aluminum coil shields, 2 in. diam. x 3½ ins. high;
- Five bakelite tubes, 1 in. diam. x 2¼ ins. long;
- Two pin jacks;
- One Blau sheet of aluminum, 15¾ x 21¼ x 3/32 ins. thick;
- One piece of hard rubber ¾ x 3 x ¼ in.;
- Thirty brass screws, 6-32, ¾ in. long;
- Thirty brass nuts, 6-32;
- Eighteen brass screws, 6-32, 3/16 in. long.

HAVE YOU HEARD?

What? Simply that there is a prevailing rumor to the effect that all Fall receivers will be equipped with '45 tubes in the good old fashioned class A connection, where good quality must be secured. It seems that the pentode must be satisfied with only a second rate position, if the rumor is correct.

This does not mean that all existing receivers using tubes in a class B connection are obsolete; but that in small sets, the '45 will again come into its own.

CLASS B APPARATUS

(Continued from page 151)

2. The core is of the M-3 type, as shown in the figure. The material is No. 29 gauge laminated iron (used in audio transformers) stacked 1.5 ins. high and interleaved. The primary and secondaries are wound as shown in B of the same figure. The primary consists of two 2,250-turn sections of No. 29 enameled wire; secondary No. 1 consists of 1,400 turns of No. 26 enameled wire and is designed for an output impedance of 500 ohms; secondary No. 2 consists of 210 turns of No. 18 enameled wire and is designed for a dynamic-speaker voice coil of about 15 ohms impedance.

Building the Input Transformer

In designing the input transformer which feeds the push-push stage from the driver, a step-down ratio must be employed so the load of the tube will be accurately matched to that of the class B grid circuit. There is, however, a more important consideration involved in this design. The maximum distortional component is that due to the third harmonic. Now if the input transformer feeding the push-push stage is designed in such a manner that a certain amount of third harmonic distortion is *purposely* introduced into the system, it will be found that this introduced distortion will be in reverse phase to that generated in the push-push output circuit and the result will be a partial cancellation of the distorting effects. In order that this be fulfilled, it is essential that the input transformer be electrically perfect; for if the leakage reactances are large, the two distortional effects will not be in direct phase opposition and cancellation will be impossible.

Since the input transformer is one of the most important pieces of apparatus in a class B amplifier, it is essential that detail consideration be given to its construction. Refer to the diagram of Fig. 3.

As may be seen, the core is of the M-3 type, from 1 x 1 in. stock, No. 29 gauge laminations being used. (It might be well to add that the size 1 x 1 in. refers to the center piece only. The end pieces are only 1/2-in. wide and 1-in. high. In all the core dimensions given in this article, the first figure refers to the width of the center piece and the second dimension to the height.) The core laminations are interleaved until the desired height is obtained.

The coils are wound as shown in B of the figure. The primary consists of 5,200 turns of No. 29 enameled wire; the secondary, 4,200 turns of No. 29 enameled wire wound over the primary as shown. Note that the secondary is wound in two sections of 2,100 turns each. As in the output transformer, each layer is insulated from the adjacent one by glassine paper and each winding by empire cloth.

The Power Supply

In the design of the power transformer for the Class B system, we are concerned with average values more than with maximum values. A transformer capable of the required regulation can be produced by a competent designer at a price not in excess of those high quality transformers heretofore available for 45 cents. The rather widespread alarm over the class B system seems totally unfounded when we recall that the new tubes draw much less heater current than the old and that this saving in the power requirements of the filament circuits may be turned to the advantage of the plate supply without the changeover resulting in any increase in cost. To be sure, the over-all regulation of the power supply must be considerably improved—but this may readily be accomplished through the use of low resistance chokes with high capacity electrolytic condensers making up for the loss in inductance. The 82 has been designed primarily for use with circuits demanding the highest regulation and by employing an 82 rectifier with a choke input filter system and a liberal supply of capacitance no great difficulty nor high cost should be encountered. Careful design means "competent" design rather than cost—and nowhere in the world is that statement closer to the axiomatic than in the radio industry.

The peculiarities of the class B system dictate the use of a brutal filter arrangement. The power transformer, however, need be only

"good," no exceptional requirements beyond logical design being necessary. The main design problems center around the output and interstage transformers. The fact that none of the transformers required employ high resistance windings of many turns of fine wire makes them readily amenable to home construction. For this reason, the practical data on the transformer construction is included herewith. The power transformer, Fig. 4, must carry a maximum load of 100 watts and the secondary winding must deliver 475 volts to each side of center tap.

Building the Power Transformer

The power transformer may easily be constructed at home if the following specifications are adhered to. Refer to Fig. 4. As shown at A, the core is of the EI-8 type construction and composed of laminations of No. 015 gauge, silicon steel, stacked 1 1/2 in. high. The width of the center portion (where the coils are wound) is also 1 1/2 in.

The primary is wound for either 110- or 120-volt supply; 400 turns of No. 20 enameled wire, tapped at the 365th turn for 110-volt operation, is placed directly over the iron core as shown in the cross-section view in Fig. 4B. When this winding is completed, a layer of empire cloth is wound over the primary and then secondaries Nos. 1, 2, and 3 are wound in a single layer.

Secondary No. 1, designed to supply 2.5 volts at 3 amperes, consists of 7.5 turns of No. 14 enameled wire. Secondary No. 2, designed to deliver 2.5 volts at 3.5 amperes for the class B output stage, consists of 7.5 turns, tapped at the center, of No. 14 enameled wire. Secondary No. 3, designed to deliver 2.5 volts at 3.5 amperes for the filament of the class A 46, also consists of 7.5 turns, tapped at the center, of No. 14 enameled wire. Secondary No. 4, used to deliver 950 volts which when rectified results in a total voltage of 400 D.C. at a drain of 200 milliamperes, consists of 5,100 turns, tapped at the center, of No. 29 enameled wire.

The primary is wound on a wooden form 1 1/2 ins. square, wrapped with light string—the string being stripped out to facilitate removal of the wooden form. Directly over the primary, the secondaries are wound in the following order: No. 1, No. 2, No. 3 all on one layer.

The Filter Chokes

Because of the wide variation in load current from no signal to signal conditions, the design of the filter choke requires careful consideration. If no signal is being received and the plate current is, therefore low (in the class B tubes), the voltage drop in the filter chokes is low and therefore the B voltage supplied to the various tubes will be high. In order to obviate this condition, the type of construction in the iron core of the filter choke should receive careful attention. Refer to the diagram in Fig. 5. As may be seen, the core is of the I-type construction and consists of laminations of No. 26 high silicon steel, stacked 2 1/2 ins. in height. Over, and insulated from one leg of this core, is wound the coil itself which consists of 3,200 turns of No. 20 enameled wire. Be sure to insulate the layers with glassine paper. Otherwise, the voltage generated during rapid surges may break down the coil.

It is interesting to know that the inductance of this choke when completed will be 8 henries with 200 ma. (D.C.) flowing through the coil. Its resistance will be 50 ohms. The air gap should be .045 ins. total; that is, .0225 ins. on each leg.

As a final precaution, be certain that the laminations are fastened very tightly so as to minimize any vibration and a consequent loss of energy. In the forthcoming issue of this publication, there will be described a high grade amplifier using the apparatus described in this article. Of course, it is readily understood the same apparatus may be used in any other amplifier using a class A 46 driver stage operating two type 46 tubes in a class B connection. If any tube other than the 46 is used to drive the class B stage, then only the push-pull input transformer need be changed. (Laminations may be obtained from the Allegheny Steel Corporation, Brackenridge, Pa.)

DRAMATIC NEWS about Radio Training



special new "no obligation" plan for home study offered by R.C.A. Institutes

A RADIO message of great interest awaits ambitious men who clip and mail the coupon below. It tells about a plan offered by R.C.A. Institutes . . . which enables you to advance yourself in radio by a new and convenient way!

R.C.A. Institutes were founded 23 years ago. They have behind them a wealth of experience gained in those years. In addition, they are associated with the most complete radio research laboratories. The resident school instructors are men of practical experience . . . the equipment modern. The courses include elementary and advanced instruction in every branch of practical radio. Tuition payments as low as \$4.00 a week.

NOW—for those who wish home study, we have a revolutionary new plan. You study at your own convenience at home—AND PAY AS YOU LEARN! This new "no obligation" plan means that you pay only for those lessons you actually receive—and are not obligated for an entire course.

You may start with an investment as low as \$9 . . . and stop there with no obligation. Nobody will question why you stop nor insist upon your continuing. Start a "no obligation" course at any time . . . So why not obtain full information on it TODAY—before you forget!

RCA INSTITUTES, Inc., Dept RT-9
Home Office: 75 Varick St., N. Y.
Chicago Office: 1154 Merchandise Mart.

Please send me complete information on:—

- Resident School Home Study
 Radio Broadcasting Radio Operating
 Radio Service Radio Operating
 Advance Service

Name Age

Address

City State

UNIVERSAL MODEL "X"
Startling! NEW! 2-BUTTON MICROPHONE \$10



Advanced 1932 superiority at today's rock-bottom prices. Same high standards, same exclusive features. Pure gold contacts. Durahum diaphragm. Is exceptionally rugged. Model X sets a new high standard for quality at a price that defies competition. For sale by dealers everywhere. New Catalogue with diagrams now ready.

Universal Microphone Co., Ltd.
424 Warren Lane,
Inglewood, Calif.,
U. S. A.

This Elaborate EXPERIMENTAL EQUIPMENT GIVEN TO ALL Students

AT NO EXTRA COST



Size of Cabinet: Height, 22 $\frac{1}{2}$ ", Length, 17 $\frac{1}{2}$ "; Weight 25 lbs.

We give to every student without additional charge his chemical equipment, including fifty pieces of regular standard laboratory apparatus and supplies and forty-two different chemicals and reagents.

Opportunities in Chemistry



Dr. T. O'Connor Sloane

Chemistry offers those who are ambitious and willing to apply themselves conscientiously, the greatest opportunities of any vocation today. Industrial firms of all kinds pay tempting salaries to get the right men. Opportunities abound on every hand.

You can study Chemistry under the well-known instructor, T. O'Connor Sloane, A.B., A.M., Ph.D., LL.D.

You Can Learn at Home

Our home study course, written by Dr. Sloane himself, is practical, logical and remarkably simple. It is illustrated by so many experiments that are performed right from the start that anyone can thoroughly understand every lesson. Dr. Sloane will, in addition, give you any individual help you may need in your studies.

Easy Monthly Payments

The tuition is very low, and includes your laboratory outfit—there are no extras to buy with our course. You can pay in small monthly amounts, and we show you how to earn the cost of the whole course as you go along.

CHEMICAL INSTITUTE OF NEW YORK, Inc.

HOME EXTENSION DIVISION

19 Park Place New York, N. Y.

Mail the Coupon NOW!

CHEMICAL INSTITUTE OF NEW YORK.

Home Extension Division

19 Park Place, New York, N. Y.

Please send me at once, without any obligation on my part, your Free Book "Opportunities for Chemists," and full particulars about the Experimental Equipment given to every student. Also please tell me about the latest reduction in tuition price and your easy plan of payment.

NAME
ADDRESS
CITY STATE
R. C.-932

A "B" BATTERY ELIMINATOR

(Continued from page 152)

which appeared in the August, 1932 issue of RADIO-CRAFT, in Table II appears additional data on the scale of voltages obtainable at various milliamperes drains through the Mallory "Elkonodes."

The entire interrupter unit is mounted on sponge rubber; also, it is enclosed in a rectangular case of this material. At the movable end of the shorter contact spring there is a small, rivet-like piece which prevents this spring moving too far toward the electromagnet; thus, a snappy action is obtained at the break of the contacts (also, there is afforded a slight control of the frequency and wave-shape.)

This type of "B" eliminator should never be connected to the storage battery and put into operation unless there is a load resistor across the "B" negative and "B" positive terminals. For purposes of shop test this resistor should be a 6,000-ohm unit of 25 watts rating; do not confuse this load resistor with voltage divider units R1 and R2. Under this condition of shop test, the storage battery ordinarily would not be grounded. Therefore, connect the "A" positive lead of the storage battery, by means of No. 14 wire, directly to eliminator terminal No. 1, and the negative lead to terminal No. 2; thus, the cable and its relay will not be in circuit.

Make certain that there is an output load-resistor connected from the eliminator "B"

minus to "B" plus. Here is a "short-cut" for the shop man; permanently connect the 6,000-ohm load resistor across the test voltmeter terminals—thus, it will be conveniently available for testing all the eliminators (do not complete the "A" circuit until the meter, and therefore this load, are connected to the circuit).

To conclude, it may be pointed out that transformer T in the schematic circuit, Fig. 1, steps up the output of the interrupter. Rectifier V is a special, gaseous-type, half-wave tube; a lead inside the tube straps the socket's "G" and "P" connections together, while the two "F" connections are the two actual rectifier terminals.

The P terminal of the interrupter-unit (elkonode) plug is grounded to the shield can; the G terminal connects to the short contact spring and one end of the electromagnet coil; the other end connects to one of the F terminals; the other F terminal is connected to the long contact spring and all the metal-work of the interrupter.

The section called the "tuned filter" is designed to pass the usual commercial frequency of 60 cycles. This current supply unit is designed to fit, conveniently, in any one of a dozen accessible places in a car. The completed unit has outside shield-can dimensions of 10 $\frac{1}{2}$ x 7 x 3 $\frac{1}{2}$ ins. high.

TABLE II

Ma. Volts	12	15	17	20	22	25	27	30	32	35	37	40	42	45	47	50
220	2	3	4	4	5	6	6									
210	2	3	3	4	5	5	6	6								
200	2	3	3	4	4	5	5	6								
190	2	3	3	4	4	5	5	6	6							
180	1	2	3	3	4	4	5	5	6	6						
170		2	3	3	4	4	5	5	6	6	6					
160		2	2	3	3	4	4	5	5	6	6	6				
150		2	2	3	3	4	4	4	5	6	6	6	6			
140		1	2	3	3	3	4	4	4	5	5	6	6	6		
135		1	2	2	3	3	3	4	4	5	5	5	6	6	6	
130			1	2	3	3	3	4	4	5	5	5	6	6	6	6
120				1	2	2	3	3	4	4	4	5	5	6	6	6
110					1	2	3	3	3	4	4	4	5	5	5	6
100						1	2	2	3	3	3	4	4	4	5	5

ELECTROLYTIC CONDENSERS

(Continued from page 154)

The acid or salt disassociates the water in the solution or electrolyte into hydrogen ions with a positive charge and hydroxide ions with a negative charge; the hydroxide ion further disassociates into hydrogen and oxygen ions. The hydrogen ion from the above is liberated at the cathode and escapes while the oxygen ion is liberated at the anode or positive metal foil, but instead of being lost into the air, combines with the metal to form the metallic oxide, or dielectric.

The rate of oxidation is controlled by limiting the flow of current through the wound section, with a resistor of 5,000 to 10,000 ohms in series with the section. As the positive foil becomes oxidized it becomes a resistor of itself, limiting the current. When the forming is completed only .1- to .2-ma. passes through the section.

Various chemicals are added to the solutions to give the finished capacitor the desirable electrical characteristics. These have been determined by experiments, and different chemicals are used for different characteristics.

The low leakage is the most important from the user's standpoint, as the current which passes through the condenser not only is a total loss, but also causes the shortening of its life due to the continued disassociating of the chemicals into hydrogen and oxygen, which would, over a period of time, cause the electrolyte to lose its desired characteristics to such an extent that the entire surface would not be active, thereby, considerably reducing the capacity of the condenser. When used for filter purposes, the low leakage is important.

Next in importance is the breakdown voltage, for every time the dielectric is broken down with an over-voltage it is necessary to reheat the broken spots before the condenser can again function; and as the reforming uses up the chemicals in the electrolyte, the life of the condenser is materially shortened, and the resistance of the solution is increased, thus causing further losses, which in turn produces more heat, etc.

The power factor does not, in the case of electrolytics, actually represent the loss in the current, but the resistance of the solution, and for filtering purposes it has been found in experiments using the cathode-ray tube that electrolytic condensers with a power factor as high as 15 percent measured at 120 cycles at 70 degrees F filter equally as well as a condenser with a power factor of 2 percent.

We wish to repeat that the important characteristics, that is, low leakage or losses in the condenser, and high breakdown, are obtained at a small sacrifice in increased power factor, and that if the total losses are to be taken into consideration, including comeback time and internal resistance, then power factor is only a small fraction thereof. This has been determined by many experiments, and tests, and should be taken into serious consideration, especially where the condenser is not immediately placed into use and kept under constant potential, such as a radio set. Many condensers whose power factor is very low but whose leakage and comeback time are high, were found to be useless and defective, and caused considerable damage when installed

(Continued on page 177)

SERVICING A. V. C. SYSTEMS

(Continued from page 155)

In practice this ideal is not quite realized. In any receiver a certain amount of power, depending on the sensitivity of the receiver, is necessary to produce a given output. When A.V.C. is used, signals of this intensity, or greater, are reproduced at substantially the same volume; all signals of less than this intensity are reproduced at a corresponding decrease in volume. Thus it will be seen that A.V.C. serves merely to reduce the sensitivity of a receiver when necessary, but cannot increase it beyond a given point (determined by the amount of engineering skill that went into the design and construction of the receiver).

Let us take this example: our receiver is turned on at maximum volume but tuned to a frequency that at this time is unoccupied by a broadcast station. Now we may tune in a station which is far away and quite weak; consequently, if we want to enjoy his program we will have to get a more sensitive receiver. Another station, nearer, may come in with good volume. Now we tune in a local station, and as we approach resonance the volume increases, when it reaches a definite level the automatic volume control begins to function, and increases the control-grid bias voltage applied to the R.F. tubes, and thus prevents any further increase of volume. Now, if for any reason, the intensity of the signal should change, the bias is automatically adjusted to maintain the same volume—provided the signal does not fall lower than the value necessary to produce this volume when the receiver is in a state of maximum sensitivity.

Now that we have seen what the A.V.C. system does it is only natural that you ask how it is done. Let us refer again to Fig. 2A; here we used a variable resistor for controlling volume. Now if we can secure a resistor that the incoming signal will adjust—increasing the resistance when the signal is weak and decreasing the resistance in the case of a strong signal—so that the volume remains constant, then we will have A.V.C.

We know that we can change the plate-circuit resistance of a tube by varying the control-grid bias; consequently, we employ another tube V2 as shown in Fig. 2B, using the incoming signal to vary the grid voltage and thus control the plate-circuit resistance (that is, R1B).

No doubt you immediately notice that with the manual type of volume control we used only 50 volts across the resistors, while in this instance we are using from 85 to 120 volts. This extra voltage is necessary because we are unable to reduce the resistance of the tube to zero as we did the variable resistor. Therefore, there will be some voltage drop across the tube which is lost in the tube and cannot be used to bias the controlled tubes; in addition, there is the bias voltage for the A.V.C. tube itself. The sum of these voltages must be subtracted from the total voltage to find the voltage we have available to bias the R.F. tubes.

It will be noted that a three-element tube is used for the control tube, usually a '27, though a four-element tube such as a '24 can be used; in fact, quite a number of commercial receivers use this tube. It is not practical to use a type '35 or '61 tube on account of

the excessively high bias voltages required and the fact that they have no definite plate current cut-off point.

In practice, the control tube is biased to cut-off until no plate current flows, and a little beyond so that plate current will not begin to flow and reduce the sensitivity of the receiver before a satisfactory volume is attained.

Quite often a commercial receiver using A.V.C. will lack power or, on the other hand, it may fail to cut down powerful stations sufficiently.

In the first instance, the trouble may be caused by the bias voltage for the control tube being too low, or it may be that the characteristics of the control tube vary considerably from standard and the normal amount of bias is not sufficient to stop the flow of plate current. In this case the remedy is obvious. However in some instances the desired results are difficult to obtain. In such cases the following procedure is used. Remove the control tube from its socket and tune in a very weak station, it should be so weak as to be barely audible, now try various tubes in the volume control socket until one is found that does not cause our signal to disappear. If neither raising the bias voltage nor replacing the volume control tube will bring the signals up to the proper volume, then the plate resistor will have to be removed and one of a lower value substituted; the proper value can be best determined by trial.

In the second instance if the volume is too high, or powerful signals are not sufficiently reduced, it may be necessary to replace this resistor with one of higher value or to reduce the bias voltage applied to the control tube.

Another point to which attention should be called is that when the cathodes are operated at a positive potential with respect to the chassis, the controlled tubes should be heated from a separate winding on the power transformer. The midpoint of this winding should be connected to the cathodes so that there will be no difference of potential between the cathodes and heaters. In the event the cathodes should become shorted to the chassis, the A.V.C. system will be deprived of its voltage and consequently will be inoperative.

The voltages shown in Fig. 2B are only approximate and are not to be followed exactly. However, voltages as low as the minimum may not be high enough to allow a full 50 volts to be applied to the grids of the controlled tubes, and if these low voltages are used, some form of local-distance switch may be necessary to cut down the volume of powerful local stations. On the other extreme, the total voltage available within the receiver will not, in many instances, allow the maximum to be exceeded.

It will be noted in Fig. 2B that the A.V.C. tube is coupled to the plate of the last R.F. amplifier, the one immediately preceding the detector; in a superheterodyne this will be the last I.F. amplifier.

In addition to this method, there is another way of coupling the A.V.C. tube: this is shown in Fig. 2. Here it will be seen that the control grid of V3 is directly connected to the cathode of a power detector V2; a screen-grid tube as V3 is shown in this instance as it is usually

(Continued on page 189)

ELECTROLYTIC CONDENSERS

(Continued from page 176)

in radio sets and left on a dealer's shelf for three months before being sold or used. These condensers had low power factor but long comeback time and high leakage.

It is therefore desirable that condensers be judged by taking into consideration the sum of the leakage, the comeback time, and the power factor, and at the same time the breakdown voltage, and a decision should not be made on any single characteristic of a condenser.

On account of size and economy, with due consideration to life, including the characteristic of rehealing due to an overload, we feel

that the electrolytic condenser is here to stay, and will take its proper place in the electrical industry. New uses are being found, and with constant improvements we believe it will ultimately replace a large number of the present bulky and expensive capacitors using other dielectrics.

(Additional and extensive data on electrolytic condenser design, construction and use appeared in the article, "All About Electrolytic Condensers," by Sylvan Harris in the September, 1930 issue of RADIO-CRAFT.—Technical Editor.)

Service Men TAKE NOTICE

J. R. Williams, E.E.,* originator and designer of such service instruments as the Supreme Diagonometer, Confidence English Reading Tube Tester, etc., etc., is preparing complete and minute details on the construction and use of all types of service equipment—mostly new inventions. Nothing left out. Measurement drawings and detailed construction.

Within the next few months there will be such releases as Condenser Dielectric Leakage Tester, English Reading Tube Tester, "Resonator," a new method for peaking and aligning, etc.

You get this for \$2.00 a year.

Many months of research and design are behind each release and you will save over \$2.00 on each and every construction.

You will receive detailed construction data on complete large Central Service Station Test Boards. In fact, you will receive one release after another in such complete and concise detail you will be equipped with all necessary knowledge and drawings to build the latest and finest of all radio test equipment.

All of this for \$2.00 a year.

You will know the problems of each device. Nothing to guess about. The first release will be ready shortly after this publication reaches you.

Send your \$2.00 now to

J. R. WILLIAMS AND SONS,
519 Palm Street
Little Rock Arkansas

*Chief Engineer, Apparatus Design Company.

The Voltage "POLICEMAN" in Your RADIO

AMPERITE improves radio, protects tubes and parts. Money-maker for Service men. Send \$1.62 to Dept. RC-9 for dealers' sample and sales helps.

AMPERITE Corporation
501 BROADWAY, NEW YORK

AMPERITE
Self-Adjusting
LINE VOLTAGE CONTROL



Readrite

No. 550

OSCILLATOR

Licensed by A. T. & T. Co.

\$18 Net to dealer
\$30 list

\$21 Net to dealer
with output meter

If not at your Jobbers we will ship direct when remittance accompanies order.

A sturdy modulated instrument carefully made. Completely shielded with separate battery compartment. Furnished with 22½-v. and 3-v. batteries and one '30 tube. Direct reading broadcast band (550-1500 kc.) and intermediate band (120-185 kc.). Sharp 2d and 3d harmonics for 260 and 475 kc. Operating instructions attached in case cover with shielded wire leads. Very compact. In leatherette case, 6x11½x5½ in. Weighs but 8 pounds. Built to high standards. Every serviceman should have the No. 550 oscillator to align r.f. gang condensers, locate defective r.f. transformers, adjust i.f. transformers, check oscillator stage and determine sensitivity of a receiver. A necessary instrument. Get yours today. Write for catalog of servicing instruments.

Readrite Meter Works
17 College Ave.
Bluffton, Ohio

Please send all information about Readrite Oscillator and other service instruments.

Name
Address
City State

Readrite Meter Works

Established 1904

17 College Ave., Bluffton, Ohio

ticularly cautioned in the matter of protective measures in outdoor systems. Several typical P.A. systems for outdoor service are described.

7 P.A. *Design of Outdoor Public Address Systems*—While the previous book is devoted to outdoor P.A. systems in general, this one deals specifically with electrical and mechanical design of a number of well-known commercial installations. A special study is made of municipal P.A. systems and the center two pages are filled with detailed wiring diagrams of a typical system for a small city. All details are shown from the microphone right through to the loudspeakers connected to various parts of the city.

8 P.A. *Indoor Public Address Systems*—Although similar equipment is used for both indoor and outdoor P.A. systems, the applications of the apparatus involves special problems in each case. The systems adapted for use in halls, churches, hotels, auditoriums and schools are studied separately in this book. One of the newest applications is the use of P.A. systems in place of old fashioned buzzer call alarms in factories.

9 P.A. *Design of Indoor Public Address Systems*—When a sound technician is called on to install an indoor P.A. system, his first step is to get a clear picture of what his customer expects to accomplish with the installation. This book gives some excellent advice from the business as well as the technical standpoint and includes diagrams and illustrations of representative installations. A complete centralized radio system for a hotel or an apartment house is also described.

10 P.A. *Analysis of Photophone, Vitaphone and Movietone Systems*—Technical Men who have always been confused by the differences between the Photophone and Movietone systems of sound on film talking motion pictures will find this booklet very enlightening. The methods of recording and reproducing sound pictures with these systems is especially well described and illustrated. The Vitaphone system of sound on disc is also described.

11 P.A. *Studio Sound Shooting—Part I*—This book gives an intimate insight into the methods and equipment employed in the making of sound motion pictures in the studio. Such details as the placement of the microphone, the silencing of the cameras and the members of the studio staff are all treated for the benefit of those that have never been in a studio.

12 P.A. *Studio Sound Shooting—Part II*—This book continues where the previous book left off. It studies the various problems encountered in actual sound pictures such as the making of orchestration, pre-scoring and post scoring, the combination of sound with cartoons, re-recording the photographic side of the work is covered by several paragraphs on developing and printing of the films.

13 P.A. *Sound Picture Theater Equipment*—Fundamentally, or theoretically, all sound picture installations are alike. These consist of three essential units or devices: first, the sound reproduction; second, the amplifier and third, the sound picture projectors, or the loudspeakers. The function of each part is considered separately and practical operating instructions are given.

14 P.A. *Trouble Shooting Sound Motion Picture Equipment*—Apparatus as complicated as talking picture equipment is bound to develop electrical and mechanical troubles. Most of the electrical troubles will present no difficulty to the experienced Radio Man but, of course, the motion picture problems will require study. This book is written entirely from the practical standpoint and contains many useful suggestions for the projectionist.

15 P.A. *Control and Operation of Sound Picture and P. A. Systems*—This book follows up number 14 P.A. It deals with the inspection and care of standard types of equipment as well as means of the "running the show" under various circumstances.

QUASI-OPTICAL HOME EXPERIMENTS

Beginning with the October issue of RADIO-CRAFT, a new column dealing with Quasi-Optical Home Experiments will be conducted by John Brennan, Jr., well-known radio author.



3 Valuable New Books

Formulas and Recipes Radio — Mathematics

Presented here are three brand new books, of diversified nature, which are most educational and instructive. Each book carefully treats a subject in full, and is prepared by an expert in the field. The books are well written and thoroughly illustrated to make the contents easily learned. Get these books promptly—mail coupon below.

1. FORMULAS AND RECIPES for the Practical Man

This book has been compiled by S. Gernsback, a well-known author of practical instructional manuals in various scientific fields. It is extremely helpful and will show you how to save money by making in your own home, at a fraction of the regular cost, the hundred and one preparations which you now buy for use at home or business.

HERE ARE PARTIAL CONTENTS:

1. Adhesives; Glues; Cements; 2. Cleaning; Stain Removers; Bleaches; 3. Metal Craft; Coloring; Oxidizing; Plating; Polishes; 4. Paints; Colors; Stains; Varnishes; 5. Glass-Working; Cutting; Drilling; Boring; Etching; Engraving; 6. Wood-Craft; Fireproofing; Acid-proofing; Waterproofing; Furniture Polishes; 7. Inks; Sympathetic; Invisible; Holograph; 8. Photography; Developers; Emulsions; Fixers; 9. Antidotes for Poisons; Remedies for Burns and Scalds; Disinfectants; 10. Preparation; Manipulation; Handling; Mixing; Tables of Weights of Measures; Useful Tables.

2. FUNDAMENTAL PRINCIPLES OF RADIO Radio Simply Explained—Its Origin, Nature and Functions

The book, written by Louis Martin, has been prepared with special consideration given to young members in the radio profession, and those who have gained their experience in a haphazard fashion. This radio primer is a handy fundamental aid for "checking up" and systematizing your knowledge of radio. Regardless of how much you know about the subject, you should read this book.

HERE ARE PARTIAL CONTENTS:

Chapter I—Fundamentals of Radio; Electricity; Resistance; Batteries; The Magnetic Circuit; The Magnetic Field; Inductance; Condensers; A.C. Circuits; Propagation of Radio Waves; Chapter II—The Simple Radio Set, Single, Two, and Three-Circuit Tuners, The Battery Set, Vacuum Tubes, Electric Sets, Loud Speakers; Chapter III—Diagrams, How to Read Them; Chapter IV—Amateurs and Broadcast Stations, Talking Pictures, Television.

3. ELEMENTARY MATHEMATICS for the Technician and Craftsman

This manual has been especially prepared for the man who wishes to acquire a working knowledge of the elementary principles of mathematics. A complete treatment of the subject is given by the author, Mr. C. Shainmark, with special attention to the use of mathematics in Radio and other technical work for those who employ its formulas daily.

HERE ARE PARTIAL CONTENTS:

I—Arithmetic; Addition, Multiplication, Subtraction, Division, How to Use Decimals; II—Fractions, Percentages, Ratio and Proportions; III—Powers and Roots; IV—The Metric System; V—How to Measure Surfaces and Volumes; VI—Mathematics for the Manual and Technical Craftsman; VII—Special Mathematics for the Radio Technician; VIII—Commercial Calculations, Short-cut Arithmetic, Interest Calculations, Discounts; IX—Weights and Measures; X—Useful Tables.

All our books are of uniform size, 6 x 9 inches, and contain 64 pages. The books are printed on strong paper with stiff colored covers.

Clip and Mail Coupon TODAY!

PRESS GUILD INC., 16 Murray St., New York City. RC-9

Enclosed find \$.....for which mail me postpaid the following books:

No. 1
No. 2
No. 3

50c each, Postpaid.

Name
Address
City and State

HOW TO USE A SET ANALYZER

(Continued from page 156)

the plate current; record in column 11. Now subtract the value in column 10, from the value in column 11 and record this new value in column 12; the latter figure is an indication of the tube's condition.

Having completed all readings for the R.F. tube, remove it from the tester and replace it in the receiver. Follow the same procedure in testing the first-detector tube.

The oscillator tube is tested very much like the "35- and "24-type tubes. First measure the filament voltage on the 4-volt scale; plate voltage on the 300 volt scale; plate current on the 12-ma. scale; and finally, the grid voltage.

Measurements are now made on the I.F., second-detector and first A.F. tubes, following the same general procedure as outlined for the other tubes.

The two pentode tubes are tested differently. Place the test plug in the pentode socket and the pentode tube in the five-hole socket. Measure the filament voltage first by setting the A.C. selector switch to the 4-volt position. Next set the master selector switch to the "P-K 300" volt position. Normal plate current for this tube, about 32 ma. is measured on the "P-60 MA" scale; screen-grid voltage, on the "K-II 300" volt scale. Screen-grid current is measured by turning the selector switch to the "K-12 MA" position; and for control-grid voltage, to the "G-II 30" volt position. The chart is filled out in the same order as described for the other tubes. Control-grid voltage is recorded in column 6, screen-grid voltage in column 7, screen-grid current in column 9 and plate current in column 10.

The final tube to be analyzed is the rectifier. Place it in the four-hole socket in the tester and place the test plug in the rectifier socket. Turn the A.C. selector switch to the "H-II 8" volt position and read filament voltage on the A.C. voltmeter; then, read at the "P-II 800" volt position and record in column 5 leaving room for the other plate voltage recording in the same column; finally, read at the "G-II 800" volt position and record the second plate voltage in column 5. *It is well to remember that this plate voltage reading represents the A.C. plate voltage applied to the rectifier and should not be confused with D.C. plate voltage applied to the other tubes.*

Turn the A.C. switch to the "off" position and turn the master selector switch to the "P-120 MA" position; record in column 10. Reset to "G-120 MA," read the second plate current and record in column 9. A 20% variation in the two readings is permissible; otherwise, a new tube should be tried and if they still widely differ, then the rectifier circuit should be investigated for grounds, opens or shorts.

Since every stage has been investigated, we can analyze the entire circuit from our readings by closely examining the chart which we have made out.

Once it has been properly made out, a good Service Man can, by examining the diagram of the receiver and referring to the chart, in nine cases out of ten, tell exactly where the trouble is without removing the chassis from the cabinet.

Importance of Voltage Chart

For example, suppose no plate voltage was indicated for the R.F. tube in Fig. 4. This would lead us to believe that the plate circuit was open or that there is a ground or short along the circuit at some point; or, on finding that there is no plate current, you know that these faults exist.

Examining the cathode circuit, we find two .5-mf. condensers, C1, C2, connected from cathode to ground. If either should short, the plate voltage would be low and the plate current, high; and if the 250, 500, 1,000 1,800 or 600 ohm resistors, R1 to R5 in the cathode circuit should be open, the result would be a lack of plate voltage. Examining the plate circuit further, we find that if the .1-mf. condenser C3 should short, or the tuning meter M should open, there would be no plate voltage.

This complete analysis, of course, assumes that the power pack is functioning properly;

otherwise, tube voltages would be incorrect.

What has been said in regard to the R.F. tube also applies to the I.F. tube as the two have common circuits. Thus, it is seen that with a good set analyzer, a circuit diagram and the proper line of reasoning, one can tell almost at a glance just where the trouble lies. Even though you cannot tell definitely where the trouble is, you can narrow the possibilities of trouble down to two or three places. Even a diagram is not absolutely necessary, the only real essential being the set analyzer. There are troubles, of course, such as chronic hum that do not show up so easily on the set analyzer; nevertheless, the search may be narrowed by checking the tube circuits, thus indicating shorted or open bias condensers or resistors.

If, in testing power packs, it is necessary to test high voltage secondary potentials above 800 volts, the test leads should connect only to one outside tap and the center-tap of the winding.

To measure A.C. line voltage, use the two test leads which are attached to the A.C. plug, then plug these into the "160-volt A.C." tip jacks, plug the A.C. connection into the line outlet, and read the line voltage on the A.C. voltmeter.

If small values of A.C. are measured, insert the two test leads into the "20 MA. A.C." jacks, taking care to prevent shunting this meter across the circuit. If high A.C. values are to be measured, the three jacks indicated for Nos. 5, 6, and 7 should be used depending on the range to be covered. The A.C. selector switch must be set in the "Amps" position, otherwise possible damage may result.

In testing the R.F. type pentode tube, jack "Pentode Set" is connected to the "Pentode-Grid" connection in the R.F. section of the receiver and the short lead in the tester is inserted in the jack marked "Pentode-Grid" (to the right of the four hole socket). To complete the measurement, the master selector switch is turned to the "P-K 30" volt position and the bias voltage is then read on the 30-volt scale of the D.C. meter.

Jacks lettered "Pentode Set" to "12-60-120 MA. D.C." may be used for many purposes. For instance, in measuring the voltage drop across the filter choke or across the field of the dynamic speaker the master selector switch should be turned to the "PK-300" or "PK-600" volt position. A good way to test the input filter 8 mf. electrolytic condensers C4, C5 for shorts would be to use the high voltage range of the meter. By placing the test leads across each section of the voltage divider an indication of shorted or open resistor sections or shorted bypass condensers may be obtained.

At this point, it will be well to notice that jacks "12 V., D.C., 4-8 V., A.C., 100 MA" are used for both A.C. and D.C. measurements. The master selector switch controls the 12-volt D.C. range when it is turned to the "H-II 12" volt position; the A.C. selector switch controls the A.C. measurements to be made from these jacks. Therefore, always be sure to use the correct selector switch.

Additional Uses

To use the output meter, the master selector switch must be turned to the "Output" position. The "Low" range is usually used in testing the voice coil of a dynamic reproducer; the "Medium" range, a magnetic speaker or output transformer winding; the "High" range, for connection from the plate of the output tube to "B" negative, or the receiver chassis.

Continuity tests are easily made on the Jewell 444 set analyzer; use the jacks in the schematic circuit on page 93 of the preceding issue of RADIO-CRAFT marked "—" and "High" (extreme right); always insert the black lead in the "negative" jack. Now turn the master selector switch to the "Res-Con" position. Finally, short the two test leads and adjust the large bakelite knob under jack "High" until the D.C. meter reads full-scale. If the resistance of the unit under test does not exceed 100,000 ohms, it will be indicated on the D.C.

(Continued on page 181)

Train Now for New RADIO Opportunities



**Get Into a Line
Where There's
Action—**

**Every Day—And a Pay-
day Each Week — You
Be the Boss!**

YOURS
without extra
cost.

Right now while hundreds are looking for work where there isn't any, the radio service field can use trained men. With the proper training and the necessary equipment you can enter this field and make a comfortable living. We include with our course this modern set analyzer and trouble shooter without any extra charge. This piece of equipment has proved to be a valuable help to our members. After a brief period of training, you can take the set analyzer out on service calls and really compete with "old timers." We show you how to wire rooms for radio—install auto sets—build and install short-wave receivers—analyze and repair all types of radio sets—and many other profitable jobs can be yours.

Teaching you this interesting work is our business and we have provided ourselves with every facility to help you learn quickly yet thoroughly. If you possess average intelligence and the desire to make real progress on your own merits, you will be interested in our plan.

ACT NOW—MAIL COUPON

Start this very minute! Send for full details of our plan and free booklet that explains how easily you can now cash in on radio quickly. Don't put it off! Write today! Send now!

RADIO TRAINING ASSN. of AMERICA
Dept. RCA-9, 4513 Ravenswood Ave., Chicago, Ill.
Gentlemen: Send me details of your Enrollment Plan and information on how to learn to make real money in radio quick.

Name

Address

City..... State.....

SHALLCROSS Set Tester



**Compact, Convenient,
and Light in Weight**

This instrument, which is completely described and illustrated with diagrams and photographs in our Bulletin 160-P, uses a special set of Shallcross Super Akra-Ohm wire-wound Resistors. Special prices on this complete kit of Resistors, together with a copy of Bulletin 160-P, which gives instruction details and full information on the operation of the Tester, will be supplied upon receipt of 4c in stamps.

Shallcross Mfg. Company
ELECTRICAL SPECIALTIES
700 PARKER AVENUE
Collingdale, Pa.

Radio Service Men



MEMBERSHIP
AS OF JUNE 1, 1932
15,365

To

MANUFACTURERS,
DISTRIBUTORS,
JOBBERs and
DEALERS

If in need of Service Men wire or write us and we will send you the name and address of Service Men in your city or vicinity.

THIS SERVICE IS FREE TO THE RADIO TRADE.

OFFICIAL RADIO SERVICE MEN'S ASSOCIATION, Inc.

98 Park Pl., New York, N.Y.



JOIN THE ORSMA

EVER since the appearance of the commercial radio broadcast receiver as a household necessity, the Radio Service Man has been an essential factor in the radio trade; and, as the complexity of electrical and mechanical design in receivers increases, an ever-higher standard of qualifications in the Service Man becomes necessary.

The necessity, also, of a strong association of the technically-qualified Radio Service Men of the country is forcing itself upon all who are familiar with radio trade problems; and their repeated urging that such an association must be formed has led us to undertake the work of its organization.

This is the fundamental purpose of the OFFICIAL RADIO SERVICE MEN'S ASSOCIATION, which is not a money-making institution, or organized for private profit; to unite, as a group with strong common interests, all well qualified Radio Service Men; to make it readily possible for them to keep up with the demands of their profession; and, above all, to give them a recognized standing in that profession, and acknowledged as such by radio manufacturers, distributors and dealers.

To give Service Men such a standing it is obviously necessary that they must prove themselves entitled to it; any Service Man who can pass the examination necessary to demonstrate his qualifications will be elected as a member and a card will be issued to him under the seal of this Association, which will attest his ability and prove his identity.

The terms of the examination have been drawn up in co-operation with a group of the best-known radio manufacturers, as well as the foremost radio educational institutions.

We shall not attempt to grade the members into different classes. A candidate will be adjudged as either passing or not passing. If the school examining the papers passes the prospective member as satisfactory, we shall issue to him an identification card with his photograph.

If the candidate does not pass this examination the first time, he may apply for another examination three or six months later.

There is absolutely no cost attached to any service rendered by the Association to its members, no dues, no contributions.

If you wish to become a member, just fill out the coupon below and mail it to us. We will send you all the papers necessary to become a member.

The following firms have cooperated with us in formulating the examination papers: The Crosley Radio Corporation, Cincinnati, Ohio. Mr. D. J. Butler, Service Mgr. Grigsby-Grunow Company (Majestic), Chicago, Ill. Mr. L. G. Wilkinson, Service Mgr.

Stromberg-Carlson Telephone Mfg. Co., Rochester, N. Y. Mr. E. S. Browning, Service Mgr.

Colin B. Kennedy Corp., South Bend, Ind. Mr. B. F. McNamee, Prod. Mgr. RCA-Victor Company, Inc., Camden, N. J. Mr. H. C. Grubb, Vice-President. Stewart-Warner Corporation, Chicago, Ill. Mr. T. N. Golten, Service Mgr.

The schools who have consented to act as an examination board are: International Correspondence Schools, Scranton, Penna. Mr. D. E. Carpenter, Dean. RCA Institutes, Inc., New York, N. Y. Mr. D. O. Whelan, President.

East Bay Radio Institute, Oakland, Calif. Mr. T. T. Tonnehilt, Director. Radio Training Association of America, Chicago, Ill. Mr. A. G. Mohaupt, President.

Radio College of Canada, Toronto, Canada. Mr. J. C. Wilson, President.

Radio Division, Coyne Electrical School, Chicago, Ill. Mr. H. C. Lewis, President.

MAIL COUPON TODAY!

OFFICIAL RADIO SERVICE MEN'S ASSOCIATION, Inc. RC-9
98 Park Place, New York, N. Y.

I wish to become a member of your Association. Please mail me the examination papers and application blanks.

Name

Address

Town State

THE SERVICE MAN'S FORUM

(Continued from page 157)

information should lead you to believe that your cooperation with us would not alone be of financial benefit to us, but also untold benefit to your purchasers. This surely must be of great interest to you.

This week, since writing to you, we have had four more of your sets in for repairs: Two open R.F. coils, two burned out resistors, two shorted condensers. Now rest assured, we well know the tricks of the trade, and, when these sets leave our shop and go back to your customers they will be supplied with parts equal if not far superior to those which became defective, and that these sets will operate with equal if not greater efficiency than they did when they came to the purchasers: This much you at least should thank us for.

Under the circumstances (since Atwater Kent sets come to us, and rest assured that there will be hundreds of them) I shall certainly appreciate having your letter to show each of these purchasers of your sets as to the earnest cooperation received from you to assist them in repairing their sets. Of course, if you were the only manufacturer of "parts," and, if your parts were of such a high grade that your sets never needed repairs, the matter would be a horse of a different color; but, when nearly half of the sets received for repairs are Atwater Kent, we are almost lead to believe that we should, in the interest of our business, and with the hearty interest of our customers at heart, purchase a much better grade of parts for these repairs.

I cannot mention within the scope of this letter, the wonderful assistance we have received from R.C.A., Crosley, Bosch, Zenith, and some seventy or more manufacturers, who have not only supplied us with clear helpful data, but have even written us letters of a helpful nature, requesting that we leave "no stone unturned" to put their sets in the best possible condition and, of course, with this in mind, we do not take all of the credit for the good repair jobs we do, but tell the customer of the kind assistance received, and, Mr. Atlee, just for one second stop and think, one thousand sets for repairs, without doubt, represents more radio sets than you have sold in Kalamazoo in the past ten years—are we dubs to be turned down cold, and, is Atwater Kent so high and mighty as all of this?

Anyway, business is good with us, and we will go merrily on fixing your sets for you, and making every one of them talk so good that the customer will say "It's better than when I bought it," and will send us a lot more little Atwater Kents, so we will make a bit of money after all: And rest assured, we will explain anything any of our customers want to know, if we have to stand on our heads all the time we are doing so.

All right, Mr. Atlee, we will test out all your defective parts and there are a bushel right now, and get the data we need, and I am afraid the customers will have to pay for the time it takes to do it, and pretty soon, we will have all this information we need without any one's assistance.

Wishing you a very prosperous 1932, and thanking you for the information received,

Mr. K. RANDALL,
Kalamazoo Electric Co.,
Kalamazoo, Mich.

(As a business card, which was enclosed in the letter addressed to RADIO-CRAFT will be of interest to a number of Service Men, we reproduced it in Fig. 1; the original card, in black and white measured 3 x 5 inches.)

CORRECTION NOTICES

Editor, RADIO-CRAFT:

A careful examination of the circuit of my analyzer which appeared on page 410 of the January, 1932 issue of RADIO-CRAFT shows a few slight errors. The voltmeter multiplier, R2 should be marked 100 V, instead of 200 V. The two inside terminals of the phone jack should be connected with an ordinary piece of wire. The diagram might lead some to think that the phones are connected where the jumper should be. The phones are connected by means of an ordinary phone plug which is inserted into the phone jack.

The description of the tester has one error in the last paragraph, page 410 which reads: "The 225-ohm resistor R5 . . ." This should be: "The 2,250-ohm resistor R5 . . ." etc. The diagram is correct about the value of R5. While a 200-ohm resistor will help supply the 10-volt grid bias, experience shows that it is best to tap the primary of the power transformer to obtain this 10-volt drop. (See Fig. 2 for a corrected diagram.)

N. H. SILVERMAN,
2923 Vine Avenue,
Lorain, Ohio.

Editor, RADIO-CRAFT:

Regarding my article "Modernizing the Jewell 190 Analyzer" printed in the June issue of RADIO-CRAFT, page 735, I notice that there are two slight errors.

One is in the complete schematic circuit in Fig. 2. On the D.C. SW. block a wire from terminal No. 4 should connect to the wire connecting terminals No. 12 and No. 1. This wire is not shown. The other error is in the text, page 736, third column, second paragraph, first line reads, "Move the light black wire from contact No. 1 to contact No. 2 on the upper sections of the cable terminal block Fig. 6." This line should read, "Move the light-black wire from contact No. 1 to contact No. 4, etc." The contact number and wiring as shown in Fig. 6 is correct.

I hope that you will find it possible to publish a "Correction Notice" regarding this in a future issue of RADIO-CRAFT so as to avoid confusion to anyone wishing to rebuild their analyzers according to this article.

HARRY SCHMIDT,
117-03 Hillside Ave.,
Richmond Hill, L. I., N. Y.

Editor, RADIO-CRAFT:

In looking over the article by myself in the July, 1932 issue of RADIO-CRAFT on page 32 entitled "A Meterless Tube-Checker Adapter," I noticed a slight error or rather omission in Fig. 2. The omission was that of a lead from the "second plate switch," when it is in the "normal position," to grid terminal of the socket. Without this lead there will be no grid connection with the switch at "normal." The correct wire is shown dotted.

While this omission is so obvious to the reader, I thought it best to call it to your attention so that you could make note of it in a following issue if you deemed it necessary. (See Fig. 3 for corrected diagram.)

VINTON K. ULRICH,
119 West Wyoming Ave.,
Melrose, Mass.

HOW TO USE A SET ANALYZER

(Continued from page 179)

meter.

To obtain ohmmeter readings, all four jacks are available. The range indicated on the ohmmeter scale at "Low" is 0-1,000 ohms; to read on the "Medium" scale, the indicated figure scale is multiplied by 10; and on the "High" scale, by 100.

The writer has tried in this article on the use of the Jewell 444 set analyzer to give an insight into the use and application of such analyzers to those who find it difficult to understand and apply them. This article was written mainly in answer to major questions received by the writer from Service Men and students in all parts of this and various foreign countries. (Further details are given in instruction booklets which accompany all set analyzers). However, if any reader of this magazine is having trouble with his set analyzer or does not understand anything we have covered in this article, we will be more than glad to answer questions if letters are addressed to the writer in care of this magazine. Be sure to enclose a stamped and addressed return envelope!



FREE
50c
Volume Control Guide

with additional "dope" is just off the press. It is FREE with your order of only Five (5) Centralab Replacement Volume Controls. Centralab Controls are now offered at new low prices.



10 Centralab Fixed Resistors

Packed in a neat, convenient service carton (your own choice of resistance values) listing at \$3.00 and a new QUICK REFERENCE WALL CHART, showing resistance combinations at a glance . . . all for only \$1.75.

Centralab
CENTRAL RADIO LABORATORIES

930 E. Keefe Ave. Milwaukee, Wis.



FREE!
You cannot possibly afford to be without this valuable book! It is not just another CATALOG—it is indeed a VERITABLE ENCYCLOPEDIA of the RADIO INDUSTRY!
WHOLESALE PRICES
All that is New in Radio is Listed in this Money-Saving
FALL 1932—100 Page Catalog JUST ISSUED!
WE ARE HEADQUARTERS FOR
Public Address Amplifiers and Installations
You Pay ONE PROFIT! Purchase Direct From the Manufacturer! Our Amazing Low Quotations Will Astound You!
It will pay you to trade exclusively with the house of "Coast-to-Coast" . . . write for your copy of our free catalog today!

COAST-TO-COAST RADIO CORPORATION
123 R West 17th St., New York N.Y.

SEND NO MONEY--

Clip and mail to us the coupon below. We will send you either one or both books through the Express Company for your inspection. You have the privilege of keeping or returning them.

If you want to have a complete set of all Radio Diagrams, both manuals should be in your file.

Both volumes of the OFFICIAL RADIO SERVICE MANUAL will give you the most complete set of circuit diagrams ever published for the Radio Industry. Every Radio Service Man and Dealer should have them available for immediate use in his business. Professional set-builders and amateurs will find them instructive and helpful.

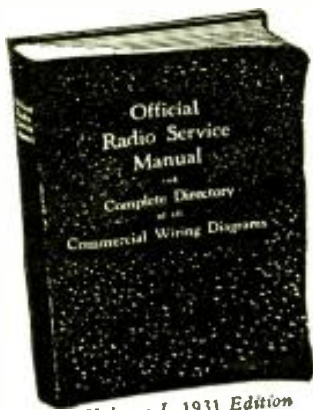

Volume I, 1931 Edition



Volume II, 1932 Edition

Briefly outlined below are the "high spots" that are to be found in the 1931 Manual—the first complete radio service manual ever to be published. Over twenty-seven thousand copies of this edition were sold to members of the radio industry. This assures you of its importance to those engaged in radio and how valuable it is to them.

Partial Contents

Wiring diagrams of radio sets manufactured since 1927, and many earlier ones of which there is any record elsewhere.

650 pages of radio-servicing material.

Complete course of instruction for Radio Service Men, dealers, manufacturers, jobbers, set builders and amateurs.

(Here are but a few of the subjects covered in the special course of instruction).

Amplifiers	Power-Supply Systems
Antennae	Radio Phonograph
Automotive Radio	Equipment
Condensers	Resistors
Detectors	Short-Wave Sets
Eliminators	Speakers
Meters	Tubes

\$4.50 Complete with Supplements

650 PAGES

(Complete with Supplements)

Over 1,500 Diagrams, Charts and Illustrations

Get Supplements FREE with the NEW 1932 MANUAL

There is so much new material in this Manual, that a Service Man or dealer would be lost without it when called to service a set. Information about new models which have been on the market only a few weeks are contained in this book. The 1932 Manual makes the service kit complete.

The 1932 Manual contains a Full Radio Service Guide and a Complete Directory of all 1931-1932 Radio Diagrams, also models of older design. Everyone in the Radio business should have a copy. Send for yours today!

Partial Contents of Volume II

A step-by-step analysis in servicing a receiver which embodies in its design every possible combination of modern radio practice; it is fully illustrated and thoroughly explained. It is the greatest contribution to the radio service field.

Chart showing the operation of all types of vacuum tubes, whether new, old or obsolete. An exclusive resumé of the uses of the Pentode and Variable-Mu Tubes and their characteristics.

Complete discussion of the superheterodyne and its inherent peculiarities. Also a special chapter on tools used on superheterodyne circuits. Schematic diagrams and circuits complete with color codings.

Important chapters on commercial aircraft radio equipment; new data on commercial short-wave receivers and converters.

Servicing and installation of public address systems and talking machine equipment.

Standardized color-codings for resistors.

Operation of old and new testing equipment; tube voltmeters, output meters, oscillators and aligning tools.

A full section on Midget radios—their design, circuits, and types. How to service them most economically.

Hundreds of schematic diagrams of older radio receivers which have never been published.

Blank pages for recording notes, diagrams and sketches; these pages are transferable to any part of the book. Coupon page for free questions and answers.

\$5.00 Complete with Supplements

OVER 1,000 PAGES
(Including Supplements)

Over 2,000 Diagrams, Charts and Illustrations

Flexible, Looseleaf Binder,
9 x 12 inches.

CLIP COUPON AND MAIL TODAY!

GERNSBACK PUBLICATIONS, Inc.
96-98 Park Place, New York, N. Y.

RC-9

Please send me for FREE inspection the books I have checked below. I understand I may examine them carefully, and should I decide to keep them, I will pay the full cost, plus the few cents for carrying charges. This offer is good only in the U.S.A.

Volume I, 1931 Manual, with Supplement, \$4.50.

Volume II, 1932 Manual, with Supplements to be mailed Free every 60 days, \$5.00.

BOTH BOOKS FOR \$9.00.

Name

Address

City State.....

NOT ONE OF THE DIAGRAMS PUBLISHED IN VOLUME NUMBER I OF THE OFFICIAL RADIO SERVICE MANUAL IS REPEATED IN VOLUME NUMBER II.

RADIO-CRAFT ANALYZER

(Continued from page 140)

receiver, the tube from the receiver is inserted in the proper socket of the analyzer, and the set is turned on. If, for instance, the tube is a '27, reference is made to the chart and the buttons that must be pressed to read plate, grid, and filament voltages are found to be Nos. 8, 7, and 11. In other words, pressing button 8 reads plate voltage on the type '27 tube, button 7 reads grid voltage, and button 11 reads filament voltage. Of course, when reading filament voltage, the A.C. side of the switch must be used. To read plate current on the tube, button No. 3 is depressed. The proper range is selected by means of the switch provided for the purpose and the "E-F" switch thrown to the "I" position.

At first glance it might appear undesirable to refer to a chart whenever voltage or current measurements are to be used. A little consideration will show that of the 47 tubes shown in the chart 43 require that button No. 8 be depressed to read plate voltage. About the same proportion holds true for the plate-current measurement.

It is in the case of special tubes that the extraordinary feature of the numbering system is appreciated. For instance, to read control-grid voltage, three different buttons must be pressed, depending upon the type of tube. If a single button marked "Control Grid" were used, the same button would not always measure control-grid volts. The confusion is obvious.

Hence, by means of the numbering system, the tester can never become obsolete provided tube manufacturers adhere to the general principles they have been following in the past, and we are of the opinion that no radical changes are contemplated in the near future.

When using the chart, the following should be rigidly observed:

(1) The left column refers to the type of tube;

(2) All numbers in all other columns refer to the button number on the analyzer that must be depressed in order to obtain the reading indicated at the top of the column;

(3) Grid No. 1 refers to the input or control-grid;

(4) Grid No. 2 refers to the screen-grid;

(5) Grid No. 3 refers to the suppressor-grid.

List of Parts

- One Alden, 6-prong plug with three-foot, seven-wire cable, type 906 WLC; (1);
- One Alden, adapter, type 964 DS; (2);
- One Alden, adapter, type 965 DS; (3);
- One Alden, 6-prong panel-mounting socket; (4);
- One Alden, 5-prong panel-mounting socket; (5);
- One Alden, 4-prong panel-mounting socket; (6);
- One Alden, insulated screen-grid clip; (7);
- One Best, 3-ermit, 6-position switch; (8);
- Two International, No. 4 plugs; (9), (10);
- Two International, tip jacks, red; (11), (12);
- Two International, tip jacks, green; (13), (14);
- Two International, tip jacks, black; (15), (16);
- One Yaxley, potentiometer, type 501MP; (17);
- Six Yaxley, push-button switches (non-locking), type 2005; (18), (19), (20), (21), (22), (23);
- Six Yaxley push-button switches non locking, type 2004; (24), (25), (26), (27), (28), (29);
- One Yaxley Junior, T.P.D.T. switch; (30);
- Two H & H, S.P.D.T. switches; (31), (32);
- One Tausig, rectifier; (33);
- One Weston, type 301, 0-1 ma. meter (50 millivolt full-scale deflection); (34);
- Six Van, multipliers for the D.C. scale, 5,000, 10,000, 50,000, 250,000, 500,000 ohms, and 1 megohm resistors; (35), (36), (37), (38), (39), (40);
- Six Van, multipliers for A.C. scale, 3,900, 8,100, 88,000, 220,000, 450,000, and 900,000 ohms; (41), (42), (43), (44), (45), (46);
- Four Van, shunts for D.C. milliamperage ranges, 12.5, 2.083, .505, .0102-ohms; (47), (48), (49), (50);
- One Van, multiplier for resistance continuity test, 4,000 ohms; (51);
- One Van, meter dial, Type 4; (52);
- One 4.5-volt "C" battery; (53);
- One Blau, instrument case, 9 x 12 x 4 ins., cover depth 1 3/4 ins. inside dimensions; (54);
- One Bakelite panel, black, 7 x 12 x 3/16 ins. (55).

RADIO-CRAFT ANALYSIS CHART

Tube Type	Fil. Volts	Plate Volts	Plate Current	Grid No. 1 Volts	Grid No. 2 Volts	Grid No. 3 Volts	Grid No. 1 Cur.	Grid No. 2 Cur.	Grid No. 3 Cur.	Cathode Cur.	Heater Volts	Full-Wave to No. 2 Plate Volts	Full-Wave to No. 2 Plate Cur.
WD-11	11	8	3	7	2
WX-12	11	8	3	7	2
41	11	8	3	7	2
44	11	8	3	6	7	..	1	2	..	5	10
49	11	8	3	7	10	..	2	5
55	11	8	3	6	1	10
56	11	8	3	7	2	10
57	11	8	3	6	7	9	1	2	4	5	10
58	11	8	3	6	7	9	1	2	4	5	10
'12A	11	8	3	7	2
'99	11	8	3	7	2
'00A	11	8	3	7	2
'01A	11	8	3	7	2
'22	11	8	3	6	7	..	1	2
'24	11	8	3	6	7	..	1	2	..	5	10
'26	11	8	3	7	2
'27	11	8	3	7	2	5	10
'30	11	8	3	7	2
'32	11	8	3	6	7	..	1	2
'34	11	8	3	6	7	..	1	2
'35	11	8	3	6	7	..	1	2	..	5	10
'36	11	8	3	6	7	..	1	2	..	5	10
'37	11	8	3	7	2
'39	11	8	3	6	7	9	1	2	4	5	10
'40	11	8	3	7	2
'64	11	8	3	7	2
Wunderlich	11	7	2	1
85	11	8	3	6	1	5	10
41	11	8	3	4	7	..	9	2	..	5	10
42	11	8	3	4	7	..	9	2	..	5	10
46	11	8	3	7	10	..	2	5
'20	11	8	3	7	2
'71A	11	8	3	7	2
'10	11	8	3	7	2
'31	11	8	3	7	2
'33	11	8	3	7	10	..	2	5
'38	11	8	3	6	7	..	1	2	..	5	10
'45	11	8	3	7	2
'47	11	8	3	7	10	..	2	5
'50	11	8	3	7	2
LA	11	8	3	7	2
'82	11	8	3	7	2
BA	3
BH	3
'80	11	8	3	7	2
'81	11	8	3	7	2
'66	11	6	1

POWER RESISTORS

Small . . . compact, of high wattage capacity

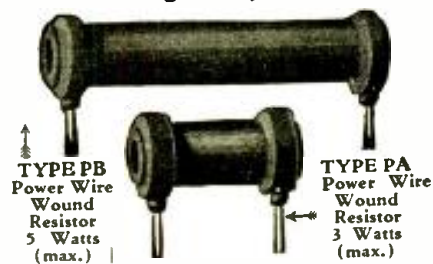

It is no longer necessary to use cumbersome, high-wattage wire wound units to take care of a 3-Watt or 5-Watt load. New I.R.C. Resistors of these capacities are now provided. They are small, compact, and with surprisingly high wattage for their size.

These 3-Watt and 5-Watt units are equipped with the new exclusive I.R.C. moulded contact. The two types sell for the same price, 50 cents list. All ranges.

Ask your jobber or write to us for complete information and other valuable resistor data, free.

INTERNATIONAL RESISTANCE CO.
PHILADELPHIA, PA. TORONTO, ONT.

I.R.C. Metallized

and Precision Wire Wound

RESISTORS

Insure YOUR WORK

with

CLAROSTAT Replacement VOLUME CONTROLS

CLAROSTAT Replacement Volume Controls are "Custom-Made" to exactly suit the receivers for which they are offered. Not a makeshift job lot idea.

The resistance, taper, shape and shaft are made according to the proper specifications.

There is no delay in installing them. There are no comebacks when you use CLAROSTAT products.

See the new CLAROSTAT CONTROL HANDBOOK AND CATALOG for 32 pages of dope for service men. Send for your FREE copy.

CLAROSTAT Mfg. Co.
285-287 N. 6TH ST. B'KLYN. N.Y.

ELECTRIC EYE!

and the various applications of this electronic tube should be known to the radio man. Instruction included in home study and resident school sound amplification courses. Write for illustrated book.

RCA INSTITUTES
75 Varick St., Dept. RT-91, N.Y.C.

HEADQUARTERS
FOR MATERIALS
AND PARTS
FOR BUILDING
Electrical and Radio
**TREASURE
LOCATORS**



Radio, Audio, Ground Potential measurements, Hughes Induction Balances and other types; Oscillators and amplifying systems included.

We supply all materials needed for building and operating any of the recognized treasure finders. The following standard circuits are described in our bulletin:

- No. 1. Ground Potential, Leap-Frog Method.
- No. 2. Hughes Induction Balance Type A
- No. 3. Hughes Induction Balance Type B
- No. 4. Sensitive Hughes Induction Balance
- No. 5. Simple Super-Sensitive Hughes Balance Circuit
- No. 6. Radio Frequency Oscillator Circuit
- No. 7. Audio Oscillator Circuit
- No. 8. Single Search Coil Hughes Induction Balance with Audio Amplifiers
- No. 9. Combination Radio Transmitter and Receiver circuit.

Also accessories such as High Frequency Buzzers, Audio Oscillators, Differential Current Transformers, Two Stage Audio Amplifiers, etc.

With all this apparatus you can locate buried treasures, metal war relics, mineral deposits, subterranean water veins, buried gas and water pipes, and lost objects, tools and treasures sunken in water, etc.

Write for pamphlet giving history and theory on this interesting subject. All above circuits are described and explained. List of parts and prices included. (Price of pamphlet 10c.)

**SHORT-WAVE
COLLECTORS**

(Continued from page 164)

high, the poor man who wanted to hear London or Madrid or Moscow or Hong Kong was just out of luck.

It is almost certain that there is nothing radically wrong with many of the receivers themselves. All they need, in order to secure a new lease on life and deliver the kind of results which the purchaser expected, is the application of a little common sense and the work of a few go-getting Service Men.

Here's How

In making a receiving system which is suitable for short wave use, a few simple rules should be kept in mind. These rules, along with the application of the information accompanying the sketches, should enable the Service Man to have everything necessary for making any receiver function satisfactorily.

(1) Put the aerial as high and as far from other objects as possible.

(2) Make the aerial as near 100-feet long as possible. If securing this length makes it necessary to run the wire over a tree or other object, it is wise to use a slightly shorter length of wire which does not pass over anything. If the aerial is thirty or more feet above everything, for its entire length, it should prove very satisfactory.

(3) Be sure that the lead from the aerial to the receiver is suitably transposed, as shown in the accompanying illustrations.

(4) The transposed lead-in should be as free from objects as possible and under no circumstances should it run close to the steel from a building. It should be as straight and as tight as it is possible to get it.

(5) Thorough insulation is especially important on short waves.

Figure 1A represents the "ideal" antenna for short-wave reception. It combines nearly every desirable feature, including marked directional properties and the latest design of noise reducing lead-in. There are two single wire flat tops (A and A') held together but thoroughly insulated from each other by the two center insulators (B). The two flat tops should be of fairly heavy gauge enamel wire, about 75-foot long and stretched directly opposite each other. They should be as free from all surrounding objects as possible and as high above ground as possible. The directional properties of this system depend to a degree upon the angle each flat top bears with relation to the other and to some extent upon the objects surrounding one or both flat-tops. The ideal condition is a pair of flat-tops, high enough to prevent shadows from surrounding obstructions, such as houses and trees, and above terrain free from buildings or large growths. The directional properties for such a system are shown in Fig. 1B.

In Fig. 1, the essentials for the system are:

(A) A and A' as described.

(B) Several insulators in series, connected together by the wires shown at E. The better the insulating properties of B, the better the entire system will work. This is especially true on short waves; insulators of poor quality glass or cheap compositions should be avoided.

(C) Heavy wire springs at each end to take up the strain and reduce fading caused by the antenna swaying. The springs used for screen doors (if of good quality) will do nicely.

(D) Pulleys, fastened to masts or corners of buildings or chimneys.

(E) Small pieces of heavy wire used to join the insulators together. Wire is much more desirable than rope for this purpose. It does not stretch and it does not absorb moisture. Enameled copper or galvanized iron will do.

(F) Good quality sash cord, passed through the pulleys (D) and used as halyards.

(G) Specially designed short-wave transposition blocks, used to keep the two lead-ins separated and permitting them to be transposed every fifteen inches to cut out the interference ordinarily picked up by the lead-in.

(H & I) The lead-in wires, which join A & A'. These wires may also be of heavy gauge enameled copper or phosphor bronze

Mail Coupon TODAY!

GRENPARK COMPANY Dept. RC-9
245 Greenwich St., New York, N. Y.

Enclosed find 10c for which kindly send me pamphlet on Treasure Finders.

Name

Address

State

CLASSIFIED ADVERTISEMENTS

Advertisements in this section are inserted at the cost of ten cents per word for each insertion—name, initials and address each count as one word. Cash should accompany all classified advertisements unless placed by a recognized advertising agency. No less than ten words are accepted. Advertising for the October 1933 issue should be received not later than August 9th.

CHEMISTRY

BECOME A TRAINED CHEMIST. Thousands of opportunities—fascinating career. Learn at home. Complete experimental laboratory outfit given. Write for big free book. Chemical Institute, 19 Park Place, Dept. RC, New York.

ELECTRIC REFRIGERATION

MEN—Learn to service Electric Refrigerators. Jobs open. Big opportunity. Write for booklet. National Tech, 4300 Euclid Ave., Cleveland, O.

INVENTORS

PATENT YOUR INVENTION: Send for FREE book, "How to Obtain a Patent," and "Record of Invention" blank. Ask us about how to protect your ideas. Deferred payment. Victor J. Evans & Co., 620j Victor Bldg., Washington, D. C.

RADIO

WANTED—Used service equipment. Write H. McClellan, 5266 Marlborough, Detroit, Mich.

GUARANTEED MICROPHONE REPAIRS—Any make or model—24 hour service. Stretched diaphragm double button repairs, \$7.50. Others \$3.00. Single button repairs, \$1.50. Write for 1932 Catalog with diagrams. Universal Microphone Co., Ltd., Inglewood, Calif.

TRANSFORMERS REWOUND, varnished, baked, guaranteed, reasonable cost. **SPEAKER REPAIRING,** magnetic \$2.00-\$2.50; dynamic, voice coils, fields, etc., reasonable charges. Clark Bros. Radio Co., Albia, Iowa.

RADIO Service Men Attention—Power transformers, re-wound or rebuilt, to your requirements. Meyke Radio Service, 2624 Margaretta, Maplewood, Mo.

RADIO INSTRUCTION

LEARN Radio, television and talking pictures in Canada. Day, evening and home study classes. Free scholarship and trip to Toronto, all expenses paid. Booklet on request. Radio College of Canada, 310 Yonge St., Toronto.

SERVICE-MEN: "How to install and service Automatic Volume Control", three parts, May, June, July Modern Radio Magazine. Only 60c for all three. Edited by Robert S. Kruse and L. W. Hatry. \$2.00 per year. 20c for sample copy. Modern Radio, Hartford, Conn.

\$500.00 SHORT WAVE Builders Contest

\$100.00 Monthly in Prizes
for Best Models

Get in on this big contest now running monthly in SHORT WAVE CRAFT. Prizes paid monthly for SIMPLEST short wave set, short wave adapter or short wave converter.

This contest centers itself around simplicity, compactness, ingenuity, compactness, novelty of circuit used, audibility and workmanship.

Do not miss a single issue.

Now 25c A Copy
GREATEST MAGAZINE
ON SHORT WAVES



At All Large Newsstands

4-Color Cover
9"x12" in Size
Over 200 Illustrations

RAPIDLY increasing each day are the number of experiments in the Short Wave field—developments which are bringing to this branch of radio thousands of new "thrill seekers." Experimenters, as in the early days of Radio, again have the opportunity to bring about stirring new inventions. Read in SHORT WAVE CRAFT, the *Experimenter's Magazine*, how you can build your own Short Wave Sets, both transmitters and receivers. SHORT WAVE CRAFT is exclusively a short wave magazine—the kind you have wished for so long.

Interesting Articles in the Current Issue

How Columbia Hauls Short-Wave Broadcasts.
How Short-Waves Indicate a Plane's Altitude.
8-Tube Portable "All Wave" Super-Het.—350 to 15 Meters.

The Short-Wave Megadyne.
Reducing Noises on Short Wave Aerials.
How to Become a Radio Amateur.
The Rotorit Crystal Detector Circuit for Short Waves.

New Tubes for the Transmitting Amateur.

SPECIAL OFFER COUPON

SHORT WAVE CRAFT RC-9
98 Park Place, New York, N. Y.
GET ACQUAINTED OFFER

- As per your Special Offer, I enclose \$1.00 (Canada and foreign \$1.20) for which enter my subscription to SHORT WAVE CRAFT for 8 months. (I understand that your regular rate for a year's subscription is \$2.50).
- Mail me a sample copy of SHORT WAVE CRAFT for which I enclose 15c (U. S. Stamps or coin accepted).

Name
Address
City State

wire. They are easily slipped into the recesses provided in the transposition blocks (G), as shown in Fig. 1. It will be noted that the wire which crosses the top block on the front, passes to the rear of the second block and returns to cross on the front side of the lowest block. This is good mechanical practice and prevents any tendency toward twisted leads.

These transposition blocks have many features. The unshaded surface, which appears in the form of a square, is highly glazed. The heavy corners, shown by the shaded section are exceptionally strong, and are made to permit the easy passing of the lead wires through the slots E, F, G, and H. The slots are placed on an angle to prevent the lead wires slipping out in the event of sagging or a severe wind storm.

Due to the formation of the heavy ends, the lead wires actually cross from diagonal corners in air and do not make contact with the block.

The cross-shaped depression serves the triple purpose of increasing the length of the leakage path, thereby reducing leakage loss; cutting down the actual thickness of the block, thereby reducing the overall weight without reducing its strength; this reduction in thickness also reduces the capacity between the lead-ins.

In carrying the lead-in wires from the aerial to the receiver, the shortest possible path should be followed; but, when the shortest path leads too close to a building having a steel frame or to any other absorbing object, it is best to increase the length of the leads and keep them away from other grounded objects. In bringing vertical leads from the central section of the ideal antenna system, it is advisable to pass them through insulators fastened to the end of rather long sticks so as to keep them as far from the building as possible until they are actually brought into the room where the receiver is located.

Leads to the receiver. Various methods of coupling the leads to the receiver are shown in Fig. 2.

In the arrangement shown at A of Fig. 2 we simply connect the two transposed lead-ins to the aerial and ground posts of the short-wave receiver. This is by far the least desirable arrangement, but it is better than connecting a regular aerial and ground in the ordinary manner.

The system indicated at B is quite good. It does eliminate the regular ground connection (which usually has plenty of noise in it) and really isolates the receiver from the actual ground. The variable condensers may have a value of about 300 mmf; the coupling coil may be just a few turns of wire. In receivers where the antenna circuit is not grounded to the chassis, the antenna coil on the regular coil form will do very nicely for L1; L2 is the tuning coil of the first tuned circuit.

A very simple arrangement is shown in C. Here the lead-ins are connected to a pair of 400 ohm resistors and then to a few turns which form the coupling unit. This system is in use at many of the most important commercial short-wave stations. It is very simple, dependable, and cheap.

The arrangement shown in D has been tried, and where there is a fair balance between the two aerials, it works quite well. However, the circuit shown in C is the best for all-around work. Where it is impossible to erect the "ideal" antenna of Fig. 1 because of the lack of space or the presence of obstructions, its performance may be almost duplicated by the system in Fig. 3A.

Here the components are the same as those described in Fig. 1 except for the introduction of the aerial spacers, X. These spacers are easily made by following the simple instructions given in Fig. 3B.

It will be noted that the upper ends of A and A' are not connected to anything and that they are run through the end aerial spacers and turned right back on themselves.

This form of aerial may have a total overall length of 50 to 75 feet and should be held very tight and transposed. The lead-in should be held tightly at its lower end, which also adds to the stability of the system.

The cage type aerial, shown in Fig. 3 has nearly as great a pick up as the system shown in Fig. 1, but it is not as directional. The freedom from noise is about equal with either system.

The New POWERIZER MICROMIKE for Public Address Systems and Home Recording

The MICROMIKE is a very sensitive, precision-built microphone, small in size and weight—easily and quickly fastened to the clothing. This MIKE when attached, permits complete freedom of movement and expression.

Simply attached by a thin, flexible, 15 foot twisted cord which is run to a connector. A small "Mikontrol" is connected between the amplifier and the MICROMIKE—it can be hidden in the pocket and controlled by hand.

The MICROMIKE is quickly adopted by educators, public speakers and entertainers. It is not a toy microphone, but is extremely practical. It has a stretched alloy diaphragm, and is gold-plated—finished in opal silver. Constructed to meet rigid tests. Furnished with fastening clip. Combined with the "Powerizer," the MICROMIKE makes an ideal portable outfit.



Front View

PORTABLE PUBLIC ADDRESS SYSTEM with Portable Powerizer PT-32, complete with Micromike Mikontrol and all tubes\$96.00
Micromike, \$12.50 Mikontrol \$3.50
MICROMIKE and MIKONTROL, sent prepaid to any part of U. S. A., upon receipt of price. POWERIZER Portable Address System shipped anywhere in this country upon receipt of \$10.00 deposit, balance C.O.D. Guaranteed for 90 days.

Send for our bulletins covering portable and permanent public address and central radio systems.

RADIO RECEPTOR CO., Inc.
106 Seventh Ave. New York, N. Y.

Headquarters for Testing Equipment

WESTON, JEWELL, SUPREME, HICKOK, DAYRAD, AND READRITE. WE HAVE THE LARGEST STOCK IN NEW YORK AND INVITE YOUR INSPECTION. Complete parts for the Ohm-Output Meter as described in the August issue of Radio-Craft. \$17.50 Blue Print\$15

Complete List of Parts for THE R-C UNIVERSAL ANALYZER as described in this issue in stock—Special Prices! BLUE PRINTS\$1.00

Headquarters for All HICKOK METERS & TESTERS The Hickok Statiktester IN STOCK

Send for Catalog

Due to the cost of packing, no order can be accepted for less than \$3.00. 20% deposit must accompany all C.O.D. orders.

SUN RADIO CO.
64 VESEY ST. N.Y.

BUILD THIS RADIO IN ONE EVENING

Pride yourself in being able to construct this electric radio—furnished with instructions and all materials required—nothing more to buy. Kit includes solid Walnut Cabinet, 4 RCA Hrensed tubes, Litz Bank Wound coils and dynamic speaker. Employs the new 57 triple-grid tubes. Set operates on 110-volts A.C. Full Vision Dial, 100 to 750 miles without aerial. Broadcast range covers 175 to 550 meters. Size 12 1/2" x 7 1/2" x 3 1/2"—weight 12 lbs. Send only \$2.00 deposit, balance \$9.95 on delivery. Postage charges prepaid in U. S. A. Completely assembled, \$13.95. Mail order today. Autocrat Radio Co., 3855 Hamilton Ave., Dept. RC, Chicago, Ill.

**\$11.95
COMPLETE**



Radio Operating
Instruction in broadcast, aviation radio. Freshen up and add to your present knowledge. Latest equipment and developments at resident schools in N. Y. and Chicago or home study. Write for illustrated book.
RCA INSTITUTES
75 Varick St., Dept. RT-93, N.Y.C.

10 NEW BOOKS in the Radio-Craft

Presented on these two pages are the new books of the RADIO-CRAFT LIBRARY—the most complete and authentic set of volumes treating individually, important divisions of radio. Each book has been designed to give radio men the opportunity to specialize in one or more of the popular branches of the industry. The material contained in these books will increase your

knowledge; you will find them a real help in your work and they will contribute to your money earning capacity. Read these books during your spare time at home.

The authors of these books are well-known to everybody. Each one is an expert radio man; an authority on the subject—each is thoroughly familiar with the field which he represents.

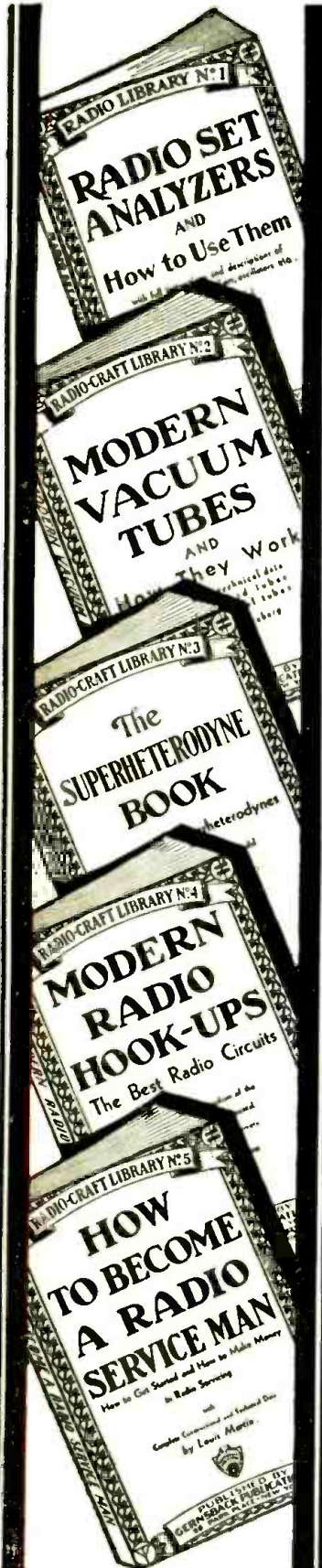

Book No. 1
RADIO SET ANALYZERS
 And How To Use Them
 With Full Instructions and Descriptions of Set Analyzers, Tube Checkers, Oscillators, Etc.
 By L. VAN DER MEL

This book explains thoroughly the operation of set analyzers, tube checkers, oscillators and other testing equipment. For every radio man this book is extremely helpful. It covers every phase of testing and gives you valuable short cuts; completely illustrated with photographs and diagrams to facilitate the use of modern testers.

The following chapters briefly outline the contents: INTRODUCTION; THE ANALYZER; Fundamentals, Scales, A.C. and D.C. Voltmeters, Calibration and Design; TROUBLE SHOOTING WITH THE ANALYZER; Classification of Trouble, Analysis of Troubles, Uses of Various Analyzers, Care and Maintenance; CONCLUSION.

Book No. 2
MODERN VACUUM TUBES
 And How They Work
 With Complete Technical Data on All Standard and Many Special Tubes
 By ROBERT HERTZBERG

MODERN VACUUM TUBES describes the fundamental electron theory which is the basis of all vacuum tube operation, and goes progressively from the simplest two-element tubes right up to the latest pentodes and thyratrons. It is written in clear, simple language and is devoid of the mathematics which is usually so confusing. Valuable reference charts and characteristic curves of standard and special tubes are to be found, also diagrams of sockets and pin connections.

Here are some of the chapters: The Edison Effect and The Electron Theory; Electron Emitters and the Ionization Effect; The Three-Element Tube; Vacuum Tube Characteristics; Four- and Five-Element Tubes; Light Sensitive Cells and Other Special Tubes.

Book No. 3
THE SUPERHETERODYNE BOOK
 All About Superheterodynes
 How They Work, How to Build and How to Service Them
 By CLYDE FITCH

There is no more fascinating a subject in the large array of radio circuits than the famous superheterodyne circuit. Whether you are a Service Man or experimenter, first-hand knowledge about the construction of superheterodyne receivers is very important. The book on Superheterodynes gives underlying principles of their construction, right from the very first set made.

The following is a short list of contents: Basic Principles of the Superheterodyne; The Oscillator; First Detector; Single Dial Tuning Systems; Intermediate Amplifier; Second Detector; Audio Amplifier and Power Supply; Commercial Superheterodyne Receivers; Servicing Superheterodynes.

Book No. 4
MODERN RADIO HOOK-UPS
 The Best Radio Circuits
 A Complete Compendium of the Most Important Experimental and Custom-Built Receivers
 By R. D. WASHBURNE

It is fascinating to the experimenter, or even to the up-to-date Service Man, to take a commercial set and to change it into one using a famous hookup that is not found in any manufactured set. Many excellent circuits have never been commercialized, but limited only to home-set builders. Thousands of these popular circuits have been requested from time to time, and in this book we have included over 150 circuits, which include the famous Perdyne, Cash-Box A.C.-D.C. Set and others.

The circuits cover the following: Broadcast Receivers, All-Wave Receivers, Short-Wave Receivers, Converters and Adapters, Television Receivers, Home Recording Apparatus, Automobile Receivers, Audio and Power Amplifiers, Power Units and Miscellaneous Equipment.

Book No. 5
HOW TO BECOME A RADIO SERVICE MAN
 How To Get Started and How To Make Money in Radio Servicing
 By LOUIS MARTIN

The ambition of many men in radio today is to become a first-grade Service Man. It is not as difficult as one might believe, but it cannot be done in a few short months. Following very carefully the advice of Mr. Martin, who has dealt with the problems of thousands of Service Men, this book deals very carefully with the essential stages in the preparation for qualifying as a Service Man.

Here are the chapters: The Small Independent Service Man; Advanced Commercial Aspects; The Radio Set; Semi-Technical Considerations; Advanced Service Data. Each chapter is again subdivided to bring out in minute detail every point of importance.

Book No. 6
BRINGING ELECTRIC SETS UP TO DATE
 With Pentodes, Multi-Mus., Dynamic Speakers—Complete Information How to Modernize A.C., D.C. and Battery Operated Receivers

In this country there are over ten million electrically operated receivers that could be modernized by placing in them new type tubes, new speaker equipment and other modern improvements. This business of improving old sets can go to the experimenters and Service Men if they will quickly jump into action.

Read in this book by Mr. Denton, how easily you can modernize any obsolete set, and with little additional costs. Here are the high lights of this book: Tubes Available for Replacements; Electrifying Battery Receivers; Use of the New 2- and 6-Volt Tubes; Operating Sets with Single Control; Conversion of A.C. Sets into D.C. and D.C. into A.C.; Replacing Output Tubes with Higher Output Tubes; Improving Old Supers; Loftin-White Amplifiers; Adapters and Their Use.

Book No. 7
RADIO KINKS AND WRINKLES
 For Service Men and Experimenters
 A Complete Compendium on the Latest Radio Short-Cuts and Money-Savers
 By C. W. PALMER

It often becomes necessary for experimenters and Service Men to call upon their memory for some short cut or radio wrinkle that will solve a problem quickly. In business, "short cuts" mean time and money saved, and to the Service Man "time saved" means money earned.

This book is a compilation of important radio kinks and wrinkles and discusses only such items as are constantly used today.

Here are some of the more important chapters: Introduction; Servicing Short-Cuts; Testing Equipment and Meters; Vacuum Tubes and Circuits; Volume-control Methods; Amplifiers and Phonograph Reproducers; Lower Supply Equipment; Coils and Tuning Circuits; Short Waves; Loud Speakers; Tools and Accessories.

Book No. 8
RADIO QUESTIONS AND ANSWERS
 A Selection of the Most Important of 5,000 Questions Submitted by Radio Men During the Course of One Year
 By R. D. WASHBURNE

There have been collected a wide variety of questions which have come into our editorial offices during the last two years, and only those whose answers would benefit the majority of men engaged in radio have been incorporated in this amazing question and answer book.

The tremendously long list of topics better explains the subjects which are treated. Here are the titles:

Radio Servicing; Receiver Design; Home Recording; Television; Sound Equipment; Short Waves; Antennas; Operating Notes; Test Equipment; Tubes; Ultra-Short-Waves; Police Radio; Reproducers; Superheterodynes; Automotive Sets; Power Packs; Automatic and Remote Control Devices; Aligning Procedure; Photo-electricity; Adapters; Measuring Apparatus; Band-Selectors; Converters; Public Address Equipment; Midget Sets; Oscillators; Phonograph Pickups.

Book No. 9
AUTOMOBILE RADIO AND SERVICING
 A Complete Treatise on the Subject Covering All Phases from Installing to Servicing and Maintenance

Automobile radios are up and coming, and someone has to service them properly. It therefore behooves you to read this immensely important new book on the art of Automobile Radio. The book is concise, and full of illustrations, photographs, diagrams and hookups.

Here are only a few of some of the really interesting chapters: Introduction; Automotive Radio Installations; Complete Descriptions of Commercial Automotive Receivers; Servicing Automotive Receivers; The Ignition System; General Service Considerations; Effects of Temperature on Power Supply; Conclusion.

Clip Coupon and MAIL!

GERNSBACK PUBLICATIONS, INC. 96-98 Park Place, New York, N. Y.

I have circled below the numbers of books in the RADIO-CRAFT LIBRARY, which you are to send me, and have deducted 20% for ordering five (5) books or more. I have included my remittance in full, at the price of 50c each, when less than five books are ordered.

The amount of my remittance is.....(Stamps, checks or money orders accepted.)

Circle numbers wanted: 1 2 3 4 5 6 7 8 9 10

Name Address

City State RC-932



Library

This is perhaps the first real opportunity that you have ever had to build a radio library of books that are authentic, right-up-to-the-minute and written so that they are easily digested and clearly understood. Mail coupon on the opposite page for your books.

Book No. 10

HOME RECORDING AND ALL ABOUT IT

A Complete Treatise on Instantaneous Recordings, Microphones, Recorders, Amplifiers, Commercial Machines, Servicing, etc.

By GEORGE J. SALIBA

If there is one subject that is fascinating to every radio man, it is that of Home Recording. Of course, this volume is not all on "Home" recording, but the information contained therein is important to commercial radio men, studio operators, engineers and others interested in this phase of radio.

The art of recording and reproducing broadcast selections is becoming more important every day to radio men, experimenters and Service Men. Equipping dance halls, auditoriums, churches, restaurants and homes with public address and amplifiers brings many extra dollars and often an excellent income.

In this book are found such topics as: Short History of the Art; Microphones; Recording Amplifiers; Cutting Heads; Types of Records; Commercial Machines; Adding Recorders to Receivers; Studio Layouts; Mechanical Filters for Turntables.

BIG DISCOUNT OFFERED

In order to make it possible for everyone to buy these books, the fifty (50) cents price has been made uniform for all volumes. You can buy these books separately, but you should take advantage of our special offer.

When Five (5) Books or More Are Ordered Deduct 20% from Your Remittance

Simply fill in the coupon below, and mail it to us together with your remittance. Checks, stamps or money orders accepted.

All Books Uniform

The books in the new RADIO-CRAFT LIBRARY are all strictly up-to-date, and written by men who know their subjects. The volumes are all uniform size, 6 x 9 inches, and contain on an average of 50 to 120 illustrations. Each book is printed on fine book paper, and no expense has been spared to make it an outstanding value for its editorial contents as well as from the mechanical standpoint.



RETARDING SECONDARY EMISSION IN VACUUM TUBES

By Raymond Szymanowitz*

It has been known for many years that hot bodies give off negatively charged electrical particles called electrons. By placing a positively-charged plate in close proximity to such a hot body, the electrons are readily attracted. Their rate of flow may be measured by placing a milliammeter in the circuit.

By employing an evacuated bulb bearing a plate and filament Fig. 1A, the meter M will indicate the flow of current (electrons) from the hot body F to the positive charged plate P.

While Fleming made use of this device for the rectification of current, it remained for DeForest to insert a third member in the bulb, thus giving birth to the modern vacuum tube and the huge industry behind it. The third element, called a "grid" may, by charging it either positively or negatively, be employed to attract or repel the flow of electrons to the plate. For example, Fig. 1B, if the plate P is charged positively by "B," and the grid G bears a negative potential "C" (with respect to the filament) the flow of electrons from the filament F to the plate P will be retarded. If, however, the grid is charged positively, it will aid the plate in attracting the electrons, thus increasing the flow of current. Since the grid is usually placed much closer to the filament than the plate, a given change in its voltage will have a much greater effect on the value of the plate current than will an equal change in the plate voltage. Hence, a very small amount of energy applied to the grid may be made to control a much larger amount of energy passing between filament and plate. (The grid voltage times the mutual conductance of the tube gives the resulting change in plate current.)

The changes in plate current with variations in grid voltage is illustrated by the characteristic curve Fig. 2 (the data for which was obtained experimentally).

If the grid is made positive, a few of the electrons are deviated from the plate circuit and flow back to the filament through the grid circuit. The electrons which reach the grid are capable of knocking out electrons from the wires of which the grid is composed. These "secondary" electrons find their way to the positively-charged plate.

In vacuum tubes employed in receiving sets, this phenomena does not usually occur as the grid, generally, has a negative bias. In oscillators, where a positive potential may be employed, secondary emission may result from electronic impact of the grid. Secondary emission can also take place from the positively-charged plate in a manner similar to the way secondary electrons or delta rays are emitted by the anti-cathode of an X-ray tube due to the bombardment of the cathode rays.

If the grid is negatively-charged so that it cannot receive electrons from the filament directly, it can emit electrons by thermionic emission. This depends upon its being either heated to a high temperature or upon photoelectric phenomena due to light from the filament. X-rays produced in the tube due to the impact of electrons at the anode may also produce this effect.

Just as electronic emission and the photoelectric effects are increased if an active material, such as alkali or alkaline metal, is placed upon the hot surface of the tube elements, so are they decreased if a less active material is employed or the temperature lowered.

The secondary electrons which are knocked out of the grid and plate material by the primary electrons arise not only from the metal itself, but from particles of active material on these parts which have been carried over by sputtering of the coated filament. A grid or plate carrying these surface impurities may, upon becoming hot, emit additional electrons.

If the grid, and in some instances the plate, are provided with a coating of a black, inert material, the number of secondary electrons is greatly reduced. One of the most efficient substances for forming such a coating is electric-furnace graphite, colloiddally dispersed in

*Technical Editor, Acheson Oildug Co.

SKINDERVIKEN Transmitter-Microphone-Amplifier Units



A FEW USES FOR THESE UNITS

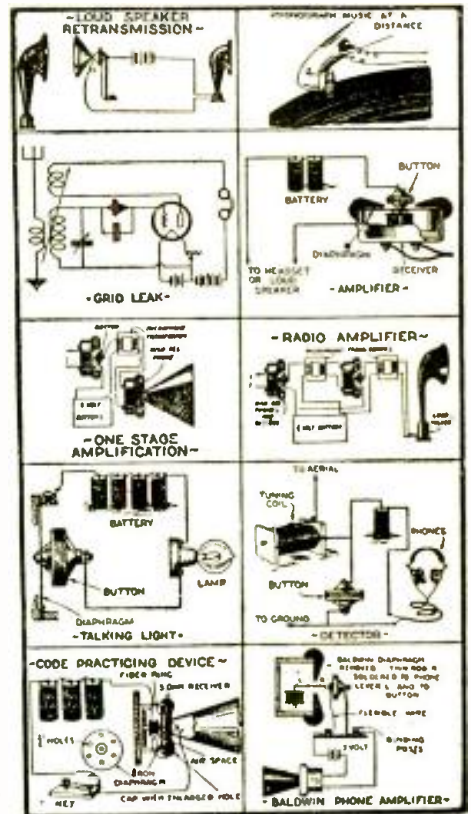

HUNDREDS OF USES FOR THE EXPERIMENTER:

- RADIO AMPLIFIER
- DETECTOPHONE
- STETHOSCOPE
- MICROPHONE
- PHONOGRAPH AMPLIFIER
- TELEPHONE AMPLIFIER
- LOUD SPEAKER AMPLIFIER
- CRYSTAL SET AMPLIFIER
- HOME RECORDING OUTFITS

WE PAY \$5.00 IN CASH for every new use developed for this unit and accepted and published by us.

One Unit 95c; Two for \$1.75
12-PAGE INSTRUCTION BOOKLET
containing suggestions and diagrams for innumerable uses, furnished with each unit.

EVERY AMATEUR SHOULD HAVE TWO OR THREE OF THESE AMPLIFIERS IN HIS LABORATORY
SEND NO MONEY

When the postman delivers your order you pay him for whatever you have ordered, plus a few cents postage.

PRESS GUILD, Inc., RC-9-32
16 Murray St., New York, N. Y.
Please mail me at once as many of the following items as I have indicated.
...Skinderviken Transmitter Units at 95c. for 1; \$1.75 for 2; \$2.50 for 3; \$3.20 for 4.
When delivered I will pay the postman the cost of the items specified plus postage.

Name
Address
City State.....

DEALERS! YOU WAITED FOR IT!

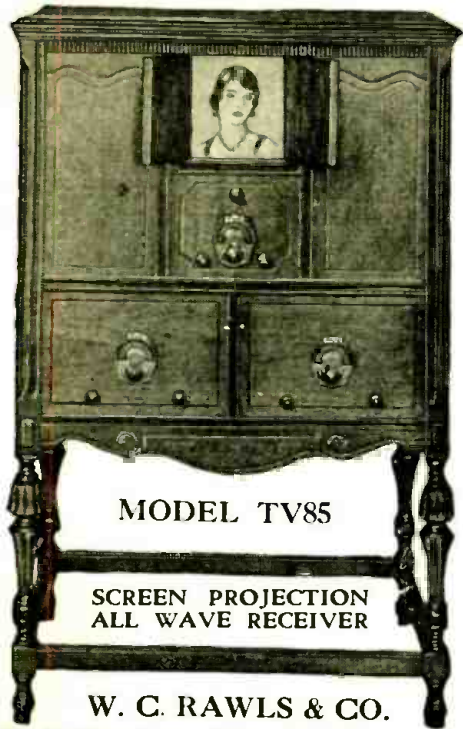

MODEL TV85

SCREEN PROJECTION
ALL WAVE RECEIVER

W. C. RAWLS & CO.
RC Bankers Trust Bldg., NORFOLK, VA.

Rawls Engineers Produced It!
The Ultimate in Television

Rawls

TELEVISION with
Synchronized Sound **\$295.00**
LIST PRICE

A Message to Moneymakers

And by moneymakers we mean dealers who are alive to new developments—dealers who are quick to appreciate the tremendous selling possibilities to the public of a Television set that provides real home entertainment. If you are interested drop us a line on your firm letterhead and we will be glad to send you full details.



Originators of
"Rawls
Yellow Base
Tubes"

distilled water. When applied to metallic surfaces by means of a spray gun or brush, it forms velvety black coatings which radiate heat very effectively thus keeping the coated parts at a relatively low temperature.

Surfaces formed with colloidal-graphited water possess little affinity for the sputtered particles from activated filaments and serve to prevent the permanent alloying of these minute bodies with the tube parts which are composed of metal and which have been graphited in the manner described above. This treatment reduces to a considerable extent, "back emission" from grids which have become overheated or which are so charged as to be subjected to the impact of primary electrons.

Graphite, being an allotropic form of carbon, provides very little secondary emission when bombarded with electrons and is very poor photoelectrically. The ease with which graphite in the colloidal state may be applied to tube parts before assembly, accounts for its popularity among tube manufacturers.

Colloidal-graphited water, as manufactured under the trade-mark "Aquadag," contains about 22% electric-furnace graphite, which is colloiddally dispersed in distilled water.

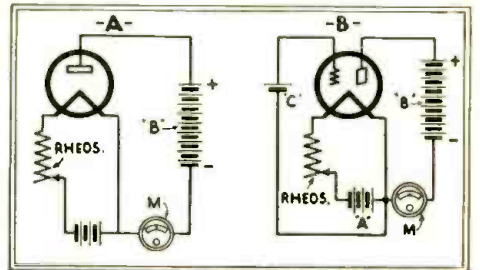

Fig. 1

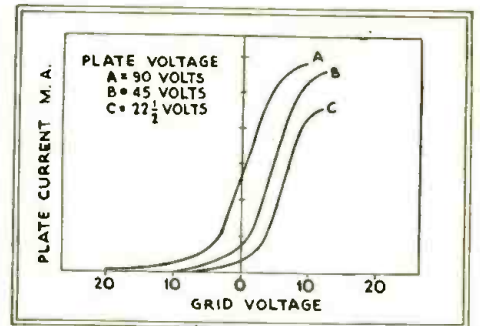
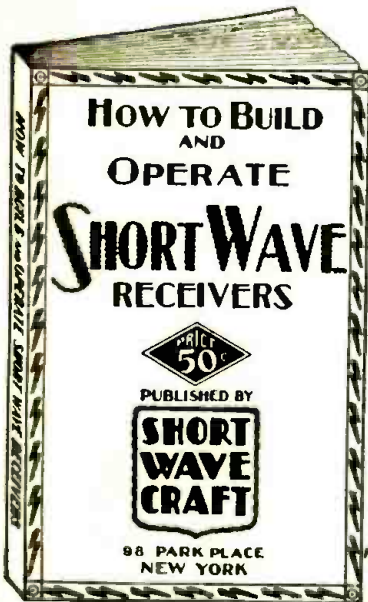

Fig. 2

..... where the thousands of Short Wave fans get their valuable information---quickly!



THE greatest book of its kind ever published. **HOW TO BUILD AND OPERATE SHORT WAVE RECEIVERS** is the best and most up-to-date book on the subject ever put between two covers.

The book has been edited and prepared by the editors of **SHORT WAVE CRAFT**, and contains a wealth of material on the building and operation, not only of typical short wave receivers, but short wave converters as well.

Dozens of short wave sets will be found in this book, which contains hundreds of illustrations; actual photographs of sets built, hook-ups and diagrams galore.

WE SAY—AND REPEAT IT—THAT NOTHING LIKE THIS HAS EVER BEEN PUBLISHED BEFORE.

The book comes with a heavy colored cover, and is printed throughout on first-class paper. No expense has been spared to make this the outstanding volume of its kind. The book measures 7½ x 10 ins.

Published by the publishers of **SHORT WAVE CRAFT** magazine. This alone will be your guarantee that it is a really worthwhile publication.

We know that if you are at all interested in short waves you will not wish to do without this book. It is a most important and timely new radio publication. 76 Pages — 250 Illustrations — Stiff Paper Covers

NOT SOLD ON NEWSSTANDS
Mail Coupon At Left!

INFORMATION BUREAU

(Continued from page 168)

rewinding dynamic reproducer field coils to different values of impedance or resistance, a general idea of the resulting unit may be obtained by reference to this tabulation.

REPLACING "MAJESTIC" TUBES

(172) Mr. F. J. E. Boehm, Gutenberg, N. J. (Q.) Are all the tubes of the Grigsby-Grunow line directly replaceable with tubes of other marking than "Majestic"?

(A) In reply to this interesting question the following quotation from the Service Department of Grigsby-Grunow Co., Inc.

"Most Majestic tubes can be used in place of tubes of other manufacture bearing the same type number. However, Majestic tubes which are "spray shield" are not always interchangeable with other tubes as this shielding forms part of the circuit (or circuit design) on Majestic receivers. If one has tried replacing Majestic Spray Shield Tubes with plain tubes of the same type but of different manufacture they will no doubt have found out that the circuit oscillates (because of the lack of the shielding afforded by the "spray shield")."

"The Majestic Duo-Diode Detector can be supplanted by a type G-27 tube when in a pinch although the type G-2 makes for better A.V.C. operation.

"In many old-style T.R.F. sets of '28 and '29, type '27 detector hum can be greatly reduced by using the G-27-S (spray shield) tube. This improvement will be noted in Majestic models 70, 70B and 180."

SHORT WAVE CRAFT RC-9
96-98 Park Place, New York City.

I enclose herewith fifty (50c) cents for which please send me a copy of your new book **HOW TO BUILD AND OPERATE SHORT WAVE RECEIVERS**. (Send money order, check, cash, or new U. S. Stamps. Register letter if it contains currency or stamps.)

Name
Address
City and State.....

On page 136 of this issue you will find an important announcement which tells about the 96 additional pages which have been added to the **OFFICIAL REFRIGERATION SERVICE MANUAL**... now bringing this valuable book right up to the minute with new servicing material.

• Index to Advertisers •

A	
Alden Mfg. Company	172
Amperite Corporation	177
Autoerat Radio Company	174, 185
B	
Hotel Blackstone	190
C	
Cable Radio Tube Corp.	Inside front cover
Central Radio Laboratories	181
Chemical Institute of N. Y.	176
Claroostat Mfg. Co.	183
Classified section	184
Coast-to-Coast Radio Corp.	181
Concourse Elec. Company	172
Coyne Electrical School	129
Crosley Radio Corp.	171
E	
Electrad, Inc.	171
Exchange	174
F	
Hotel Flanders	190
G	
Gernsback Corp., S.	189
Gold Seal Mfg. Co.	170
Grant Radio Laboratories	174
Grenpark Company	184, 191
H	
Hammarlund Mfg. Company	174
Hoodwin & Company, Chas.	172
I	
International Resistance Co.	183
J	
JMP Mfg. Company	170
Jewell Electrical Instrument Co.	173
L	
L & L Electric Company	174
Lincoln Radio Corporation	Back cover
M	
Midwest Radio Corporation	135, 136
Hotel Montclair	190
N	
National Electric Tool Co.	172
National Radio Institute	131
P	
Popular Book Corp.	185, 188
Press Guild, Inc.	172, 187
R	
Radio Receptor Co., Inc.	185
Radio Trading Company	192
Radolek Company	174
Radio Training Assn. of America	179
Rawls & Co., W. C.	188
Readrite Meter Works	178
Ross, Malcom	172
RCA Institutes, Inc.	175, 172, 183, 185
Russian Village	190
S	
Scott Radio Labs., E. H.	133
Shallcross Mfg. Co.	179
Sun Radio Company	185
T	
Triad Mfg. Co.	Inside back cover
U	
Universal Microphone Co.	175
V	
Van Leuven, D. L.	172
W	
Weston Electrical Instrument Corp.	173
Williams & Sons, J. R.	177

(While every precaution is taken to insure accuracy, we cannot guarantee against the possibility of an occasional change or omission in the preparation of this index.)

THESE THINGS CALLED HARMONICS

By His Royal Highness

"AND the output of this triple-hecktode pentode is 800 watts with but .5-percent of harmonic content." These words astounded me as nothing else could. Here my firm was manufacturing the quadruple-hecktode pentode having an output of 799 watts and .6-percent distortion—what would become of us?

To fully appreciate the significance of the above statement, one has but to seek the counsel of the texts. After reviewing 17 books and 47 papers delivered before all the engineering societies in the country, I came to the remarkable conclusion that every authority in the country differed as to the optimum harmonic content—above which the human ear recognizes distortion. The problem then became simple—we had but to change the label on the tube, rating it at 801 watts at .49 percent distortion and we were saved.

The above is not unlike present tube conditions. What does harmonic content mean? If, upon consulting a tube chart, one were to find that a certain tube, when delivering 20 watts of undistorted energy had a harmonic content of 15 percent, does it mean that the harmonics are not heard? No, not at all!

The total output consists of the undistorted output of 20 watts plus the 15 percent harmonic power. In other words, the customer not only hears the undistorted power but the distortion as well. The real test of a tube is whether or not a large amount of power may be available with *low* harmonic content. Just because a tube is capable of delivering a tremendous output means nothing, the harmonic content must be low.

Why Harmonics?

Why must a tube generate harmonics? The answer to this question is not as simple as it may seem. If the plate-current changes in a tube follow the grid voltage changes exactly, regardless of the voltage impressed, then absolutely no harmonics would, or could, be generated. But because the vacuum tube is not perfect, the plate-current variations differ from the grid-voltage fluctuations, and harmonics exist. But how do we know that it is the second harmonic in a detector that is causing the distortion?

Well, if a pure sine wave such as delivered by a tuning fork be recorded by means of a stylus on a strip of paper and if directly under this, another recording be made of the vibrations of the same tuning fork *plus* another of twice the frequency, the wave form of the latter recording would be different from that of the first—the difference, obviously, being due to the presence of the second tuning fork. By measuring the amplitude of the vibrations of the second fork and that of the first, the percent harmonic may be calculated.

Now, if the frequencies of the tuning forks used were unknown, then the percent second, third, etc., harmonics could not be calculated in this manner. In such cases, recourse must be made to the use of external oscillators for the determination.

A.V. C. SYSTEMS

(Continued from page 177)

used with this type of coupling.

In addition, all bypass condensers are shown together with the isolating resistors (usually of the carbon rod type and of the smallest size, since no current flows through them and their function is that of a choke) which are used to prevent stray or common coupling with attendant oscillation and instability. It might be well to mention that the bypass condensers should be non-inductive and of the highest quality. As can be seen, they are in parallel with the tube and if one of them develops a leak it will show up as lack of volume, or if the leak is intermittent will cause fading and erratic operation.

This preliminary discussion of A.V.C. components and their relation to each other will be continued in the forthcoming issue of RADIO-CRAFT.

In Good Company

Here are the names of a few buyers of

S. GERNSBACK'S RADIO ENCYCLOPEDIA

New York Public Library
Cornell University Library
Cincinnati Public Library
Cleveland Public Library
Cooper Union Library (N.Y.)
Portland (Oregon) Public Library
Toledo Public Library
Worcester (Mass.) Public Library
Bridgeport Public Library
New York Times
National Broadcasting Company
RCA-Victor Company
U. S. Patent Office
Bell Telephone Laboratories
Imperial Japanese Navy
Submarine Signal Company
Observatory, University of Michigan
Ecole Technique, Quebec
Hudson Bay Company
Numerous educational schools, high schools, radio schools, etc.

What the New Second Edition Radio Encyclopedia Gives You

It gives you an explanation of every word used in radio.

Practically every definition in the book is illustrated. Look up as you would in a dictionary, the word or phrase about which you are seeking information. Each page is key-indexed, for greater convenience and speed in locating any definition. All the Subject-Matter is Arranged in Alphabetical Order.

This greatly enlarged Second Edition Radio Encyclopedia is an absolute necessity to everyone interested in Radio. It answers all radio questions, increases your knowledge and saves your time. It covers every known radio problem, and is a goldmine of practical information for every radio man.

2,201 RADIO DEFINITIONS
1,253 TECHNICAL ILLUSTRATIONS
34 TABLES AND CHARTS
24 PAGES OF APPENDIX
Red Morocco-Keratol Flexible Binding
Printed on strong ledger paper, Loose-Leaf Arrangement

352 pages
9 x 12 inches
Weight 3 lbs.



\$3.98

S. GERNSBACK CORPORATION,
98 Park Place, New York, N. Y.

Send me one copy of the new Second Edition S. Gernsback's Radio Encyclopedia. I enclose herewith \$3.98, check or money order preferred. (Foreign and Canada, add 35c extra for postage.) Money refunded in full if not satisfactory.

Name

Address

City..... State.....
NC-932.

Hotel Directory of the Radio Trade

The Hotels on this page are
Patronized by the Radio Trade.
Make them your Headquarters.



THE HOTEL MONTCLAIR

LEXINGTON AVE., 49th to 50th STS.
NEW YORK

Directly Opposite the Waldorf-Astoria

800 ROOMS

Every Room With Bath
From \$3.00 per day

Attractive Rates by the Month

A RADIO IN EVERY ROOM

Short walking distance from
Grand Central Terminal
and B. & O. Motor Coach
Station. Ten minutes by taxi
from Pennsylvania Station.

*American Home Cooking Served
in a Notable Restaurant*

OSCAR W. RICHARDS, *Manager*

*"The Gathering Place
of
Cosmopolitan New Yorkers."*
The RUSSIAN VILLAGE
100 West 57th Street
New York City

Dining, Dancing, Russian and Gypsy
Entertainment.

LUNCH — TEA — DINNER

No cover charge at any time.

Broadcasting WOR Circle 7-9434

OPPOSITE the STEEL PIER

HOTEL BLACKSTONE

VIRGINIA AVE. and the BEACH
Overlooking the Ocean
ATLANTIC CITY, N. J.

1,000 CAPACITY
EUROPEAN PLAN
Ballroom - Dancing
Large Meeting Rooms
RESTAURANT
in Building

ROOMS \$1.50[▲] UP

WITH BATH
SPECIAL
WEEKLY RATES

ALL OUTSIDE ROOMS

*(The Blackstone Hotel is located
a few steps from the beach.)*

HOLD YOUR CONVENTION HERE

A HOMEY HOTEL IN THE
HEART OF NEW YORK

THE NEW FLANDERS

133 W. 47th Street through
to 48th Street

*One of the Finest Hotels in
Times Square*

Single Rooms with Adjacent
Bath \$1.50 and up
Single Rooms with Bath.... 2.00 and up
Double Rooms with Bath.. 3.00 and up
Suite—2, 3, 4 People..... 5.00

Special Weekly Rates

FRED W. BIZEL, Resident Manager

BACK ISSUES

of RADIO-CRAFT can be had at the
price of 25c each. Address

RADIO-CRAFT

98 Park Place New York, N. Y.

Important Announcement!

On pages 186 and 187
of this issue will be
found a very import-
ant announcement
telling of the RADIO-
CRAFT LIBRARY. Be
sure to turn to these
pages NOW and learn
of the ten new and in-
teresting books which
are being published.

Announcing a New Departure in Amplifier Design

POWERTONE "TREASURE CHEST" AMPLIFIER



In the manufacture of POWERTONE TREASURE CHEST AMPLIFIERS NOTHING IS SPARED IN MATERIALS OR WORKMANSHIP. Greater compactness, improved appearance, less weight, longer life, and lower hum voltage are but a few of the features built into the new TREASURE CHEST AMPLIFIER.

You will be surprised at the new brilliance of tone due to uniform amplification throughout the entire range of audibility. The high notes and the deep low notes are amplified with surprising fidelity.

ABSOLUTE HUM MINIMUM

Tubes used are 1-224, 1-245, and 1-280. For phonograph or microphone amplification there is no equal to these amplifiers. When used with mike no additional booster is necessary. A self contained B. B. L. dynamic-speaker. No. RC 247—Our Price, \$17.95 (less tubes)

POWERTONE DIRECT COUPLED AMPLIFIERS

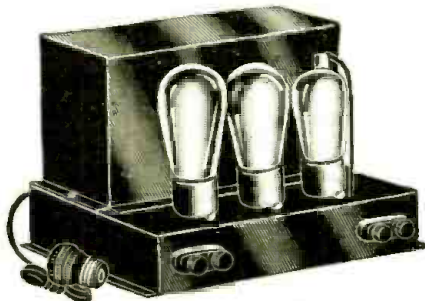

All the latest features in amplifier design have been incorporated in this direct coupled amplifier. Input terminals for permitting phonograph attachment, and in addition, by attaching the proper microphone transformer, also dry cell batteries, a microphone may be used for public address work. Any type of receiver can be connected to the input terminals without fear of loss of energy. These amplifiers are for use with dynamic speakers.

Amplifiers supply field current of 2500 ohms to dynamic speakers. Resistors are furnished when D.C. speakers are used. Amplifiers operate on 110 volts, A.C., 60 cycles.

Model RC 245 uses 1-224, 1-245 and 1-280. Output is rated at 3 watts.

No. RC 245—Our Price \$10.95 (less tubes)

Exactly the same amplifier, but employs a power pentode in place of the 245 tube. Output is rated at 2.5 watts.

No. RC 246—Our Price \$12.95 (less tubes)

Model RC 250 uses 1-224, 1-250 and 1-281. Consumption is 85 watts; maximum undistorted output, 6 watts. Gain rated at 100 cycles, 55db; gain at 1000 cycles, 52.5 db; gain at 10,000 cycles, 51.5. Input direct to 224 control grid; output direct from 250 plate.

No. RC 250—Our Price \$15.25 (less tubes)

JENKINS TELEVISION RECEIVER-KIT



The Jenkins JK-20 Television Receiver-Kit meets the requirements of satisfactory reception. Can be quickly assembled in a few hours by any handy man or boy. All parts needed are included. Kit contains metal platform, metal panel, power pack, condensers, knobs, wire, nuts, bolts, etc. Slight additional cost for tubes. The tubes are 2-427; 4-424; 1-445; and 1-480.

Assembled JK-20 receiver is of self-contained A.C. operated, single dial tuning type, covering 100-150 meter band. Ample tuned radio-frequency amplification with carefully balanced selectivity to preserve side bands essential to delicate half-tone detail. Positively non-regenerative. Audio Amplifier handles exceptionally wide frequency range with practically flat curve.

Jenkins JK-20 Television Receiver-Kit with Power Transformer.

No. RC 400—Our Price \$19.95

R.C.A. POWER TRANSFORMER For Models 80, 82 and 86

This transformer is used exclusively in the superheterodyne series. It supplies 4-224's, 2-227's, 2-245's, and 1-280. Can also be used for similar models of the General Electric, Westinghouse and Graybar.

No. RC 156—Our Price \$3.95

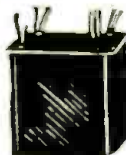

POWERTONE PUSH-PULL DIRECT COUPLED AMPLIFIERS



For use with any receiver (detector plate lead clips to input post on this amplifier) can be used as a phonograph amplifier or with any suitable microphone arrangement. Will operate one or more dynamic speakers. External field current is required to operate. Volume is exceptionally great, no distortion at all. Three-position toggle switch enables proper line voltage adjustments. Compact and durably constructed. For operation on 110-120 volts A.C., 50-60 cycles. Shipping weight, 30 lbs. Regular list price, \$100.00.

P.P. Model 245 uses 1-224, 2-245's and 1-280.

No. RC 251—Our Price \$16.95 (less tubes)

P.P. Model 247 uses 1-224, 2-247's and 1-280.

No. RC 252—Our Price \$17.95 (less tubes)

SILVER-MARSHALL AUDITORIUM AMPLIFIER

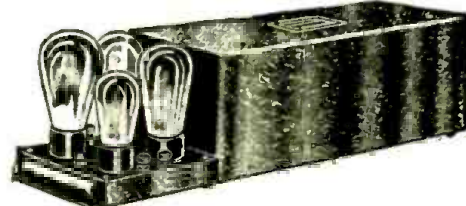

Silver-Marshall 250 Super Power Auditorium Amplifier Tubes 1-226, 1-250, 2-281.

No. RC 249—Our Price, \$12.75

POWERTONE AUTO PENTODE RADIO

The POWERTONE AUTO RADIO represents the newest development in auto radio. Uses the automotive tubes, 3-336, 1-237, and P.P.—238 for added amplification. This combination gives it stability, sensitivity and freedom from tube trouble and burnout. The automotive tubes are of the heater type, non-microphonic, sturdy construction and designed to operate over a filament range of from 6 volts to 7.5 volts. This insures equal reception when the car is at rest or when running and the generator charging the car battery, increases the potential across the battery by 1 to 1 1/2 volts.

Ease of mounting makes this a wonderful buy for radio servicemen and radio dealers.

No. RC 500—Set Only, \$22.00
No. RC 501—Complete, \$32.50

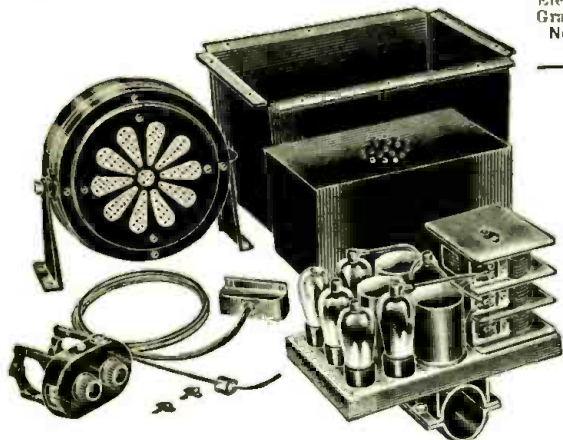

WORLD-WIDE SHORT WAVE RECEPTION

With New "Reliable" Short Wave Battery Operated Receiver

A Super Sensitive Short Wave Receiver, designed for the reception of broadcasting and code from all parts of the world.

The RELIABLE Short Wave Set uses only two tubes: 1-232 and 1-233. You will be amazed at the reception that this set will give you.

It is sturdily constructed on a metal chassis and is enclosed in a beautiful crackle finished cabinet. Tunes from 14 to 210 meters, and is extremely sensitive.

A SET YOU WILL BE PROUD OF
No. RC 504—Our Price \$9.95



WRITE FOR OUR 4-PAGE SPECIAL BARGAIN BULLETIN!

All offers are F.O.B. New York, and subject to prior sale. Terms: A deposit of 20% is required with every order. Balance may be paid on delivery. Or, deduct 2% if full amount is sent with order. Mention catalog number when ordering.

GRENPARK CO.,

Dept. RC., 245 GREENWICH STREET, NEW YORK, N. Y.

SEPTEMBER SPECIALS!!

EVERY month we list on this page certain **STAR** items, which are **NOT LISTED IN OUR CATALOG**. These are all specials of which the quantities on hand are not sufficient to catalog them. *Once sold out, no more can be had.* First come, first served. Save yourself disappointment by ordering NOW.

STOP SHOPPING. The lowest prices are right on this page. *No one underbids us.* We meet any price on ANY NEW Merchandise. Order direct from this page and save money. 100% satisfaction on every transaction. Take advantage of these special offers. **ORDER NOW, TODAY.**

IMPROVED READRITE MODEL 700 ANALYZER

EIGHT METER SCALES AVAILABLE

The "Model 700" is an extremely compact device. The outside dimensions of the carrying case are only 10 1/2" by 7 1/2" by 3 1/2" inches. The analyzer contains a D.C. voltmeter, an A.C. voltmeter and a milliammeter. The D.C. voltmeter has three ranges: 0 to 60; 0 to 200; and 0 to 600 volts. The A.C. voltmeter has also three ranges: 0 to 10; 0 to 140; and 0 to 700 volts. The milliammeter has two ranges: one for 20-mill. reading and the other for 100-mill. This variety of ranges makes it possible to test every conceivable radio circuit; high voltage secondaries of power transformers, current drain of all radio tubes, including the high power 250 and 210 tubes, etc.

CONVENIENT SELECTOR SWITCH
The instrument is equipped with a six-position bi-polar selector switch; by means of which readings may be obtained of "C" volts, "C" volts reversed, "K" volts, "K" volts reversed, plate voltage, and screen-grid voltage. A 4 1/2-volt battery is supplied with the analyzer, to provide "C" bias, for grid tests, continuity tests, etc.

TESTS PENTODES—"MULTI-MUS"
'57's and '58's—and '80 RECTIFIERS
There are two sockets on the panel of the analyzer, one for four-prong tubes and the other for five-prong tubes. There is a "grid-test" push-button. Pin jacks are available for the individual use of all meters, externally, in every range. There is a screen-grid pin jack, and there are two pin jacks for connecting the external battery. A two-way toggle switch controls the testing circuit for either regular or pentode tube.

Tests Latest Type '57 and '58
6-Prong Tubes

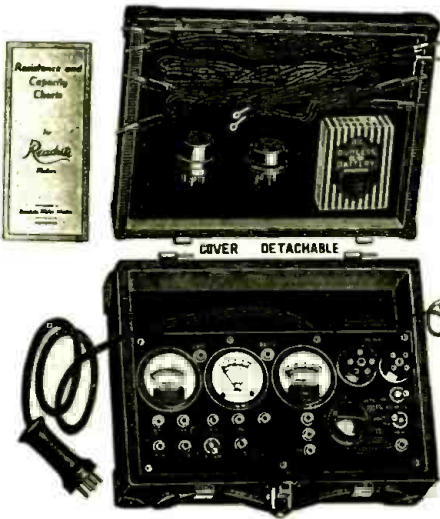

Both plates of the '80-type rectifier may be tested by use of a special adapter furnished. Charts are provided for measuring resistances and capacities.

FREE

We take pleasure in offering with the purchase of each analyzer—**ABSOLUTELY FREE OF CHARGE**—the latest radio publication to come off the press.

"Radio Set Analyzers" Contains detailed descriptions, photographs and circuit diagrams of all commercial set analyzers and testers.—**A Real Book.**

The Analyzer is furnished complete with test leads, connecting cables, Burgess 4 1/2-volt battery, several battery leads, 1Y to 1X adapter, '80 rectifier, adapter and resistance and capacity charts. Shipping weight, 8 lbs.

Model 710 Analyzer. List Price \$35.00. **Your Price \$14.70**

"MEGADYNE" ONE-TUBE PENTODE LOUDSPEAKER RECEIVER KIT

In the front part of our catalog—get your FREE copy now—there is presented a thoroughly illustrated discussion on the construction and operation of the

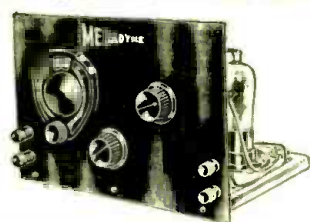

MEGADYNE Receiver by Hugo Gernsback, editor. This ingenious circuit was originally described in the July issue of the **RADIO CRAFT** Magazine. FREE copy of which will be given with each purchase. This receiver is indeed one of the most outstanding

developments in the radio industry. It is the first real one-tube receiver which will actually operate a loud-speaker. Thousands of experimenters and radio fans will want to build this remarkable receiver. For their convenience, we have compiled a complete list of parts required for its construction. These parts are of the highest quality and are exactly as specified by the author. The following parts comprise the complete kit:

1 R.M.S. Fixed Crystal Detector; 1 6-ohm Filament Rheostat; 1 3-circuit tuner for used with a .0005 mf. tuning condenser; 1 Nu-aid type 481 1Y 5-prong socket; 1 Hammarlund type M1-23 Variable Condenser; 2 sets of Cinch double binding posts; 1 Polymet .00025 mf. fixed condenser; 1 X-L Varloidsener; 1 Polymet .00025 mf. fixed condenser, or 1 Polymet .0005 mf. fixed condenser (NOTE: Only one of the latter two condensers is actually employed in the circuit); 5 Fahnestock binding posts; 1 25-ft. roll of hook-up wire; 2 black Bakelite 1 1/2" knobs; 1 Kurz-Kasch vernier dial with 0 to 100 scale reading clockwise; 1 type '85 pentode tube, "Triad" or "Speed"; 1 Bakelite Panel already drilled with all holes, size 7 x 10 x 3/16 inch; 1 hardware assortment.

The wooden base is not included. No. 2545—Megadyne Receiver Kit. **Your Price \$10.25**

WORLD-WIDE SHORT-WAVE SET



Range 18 to 200 meters. Employs low current drain 230 tube. Requires but 1/45 volt "B" battery, 2 No. 6 drycells and earphones to operate. No. 1666—S.W. Set **Your Price 6.25**

R.C.A.-VICTOR HAND "MIKE"



Designed especially for home recording and personal entertainment. Requires but a 2 1/2 volt battery to operate. Easily connected to any radio or amplifier in a few minutes. Responds indiscriminately to all speech and music frequencies. Sold complete with 6 ft. cable. Shipping weight 2 lbs. No. SP9064, RCA-Victor Hand "Mike." **Your Price 2.75**

METALLIZED DIGITAL RESISTORS AT ROCK BOTTOM PRICES

A very fortunate purchase enables us to offer these fine resistors at prices which surprise even ourselves—prices more than three times lower than in our own catalog. Resistors are guaranteed to maintain their ohmage under even adverse operating conditions. The resistance element is based on the famous metallized principle which has proven its superiority wherever accuracy and uniformity are paramount requisites. The special ceramic casing of these resistors is of sturdy construction and affords maximum heat dissipation. A feature of these resistors is their milled end-caps, tapered so they can be mounted in all standard resistor mounts. By means of their digitals, they may also be soldered in any convenient position. Available in the following sizes—all rated at one watt: 300, 450, 600, 8,000, 10,000, 12,000, 350,000. Act fast to take advantage of this offer, as the supply is limited. Sold only in lots of six or more.



Values Clearly Marked on Each Unit
No. SP2226, Metallized Resistors. **NOW YOUR PRICE 6c**
12 for 60c. **EACH**

AUTOMATIC BLOW TORCH



Heat intensity over 1200° F. Requires no mouth-blowing. Entirely automatic. Used for heavy duty soldering, aluminum soldering, metal tempering, etc. Ship. wt. 1 lb. No. K1006—Torch. **Your Price \$0.60**

8 MF. ELECTROLYTIC CONDENSERS



These guaranteed units will perform miracles in eliminating objectionable A. C. hum from A. F. and filter circuits. Easily mounted through use of bayonet socket. Shipping weight 1 lb. No. SP 9054, Condenser. **Your Price \$0.49**



A.C. SUPERHET S.W. CONVERTER

Converts any broadcast receiver into a full featured superhet S.W. Receiver. Range 20 to 115 meters. Requires no plug in coils. Has built-in filament transformer for 110 volts 60 cycles A.C. Employs 3 227 tubes. Single dial control. Instructions included. Shipping wt. 8 lbs. **NOW \$7.50**

FREE RADIO AND SHORT WAVE TREATISE

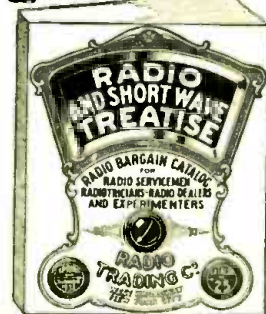

The new and enlarged Summer edition of our Radio and Short Wave Treatise, No. 26, has just come off the press—100 solid pages of useful information, radio items, diagrams and illustrations. Positively the greatest book in print—NOT JUST ANOTHER CATALOG. Contains a large editorial section with valuable information not found anywhere else. Considerable space is devoted to a **TREATISE ON SHORT WAVES** for both beginners and regular "hams." Among the new technical information listed are the following: Modernizing old radio sets—repairing speakers and headsets—making superhets out of old sets—data on constructing two-volt battery and automobile receivers—circuit of the famous Gernsback Megadyne One-Tube Loudspeaker Set—short wave coil winding data—discussion on S.W. adapters, converters and receivers, etc. etc.

100 New Hook-Ups, Etc. 1000 Illustrations.

WRITE TODAY. Enclose 4 cents for postage. Treatise sent by return mail.



MICROPHONE & PRE-AMPLIFIER OUTFIT

Excellent suited for P. A. work, inter-communication systems, etc. Comprises sensitive single-button microphone, microphone coupling transformer and battery, cut-off switch, gain control and output terminals. Put up in neat black crackle - finished metal case, equipped with convenient carrying handle. Input impedance of practically all type amplifiers. Easily connected to the broadcast receiver for home recording. Ship. wt. 10 lbs. No. 1654—Pre-Amplifier. **Your Price \$8.25**

ELECTRIC CLOCK



Act Now—Only Few Left
Naval observatory time right from your light socket! No spring to wind, no batteries. Never out of order. For 110 volts 60 cycle A.C. operation only. No. 1689—Clock. **Your Price \$1.00**

UTAH A.C. DYNAMIC SPEAKER



Operates from 110 volt 60 cycle A.C. line. 9" high by 9 1/2" wide by 7 1/2" deep. Ship. wt. 19 lbs. No. 1506—Speaker. **Your Price \$7.45**

RADIO MIRROR PENLIGHT



A clever device for looking around corners or other inaccessible spots on the radio chassis. Comprises pen flashlight and magnifying mirror. Operates with battery and bulb. No. 1695—Penlight. **Your Price \$0.85**

NEW PENTODE ADAPTER



A new and simple device for replacing the old '45 type power tube with the latest super-power pentode. Remove the '45. Insert adapter in vacuum socket and then place a pentode tube in the socket of the adapter. Gives added life and power to old receivers and amplifiers. Shipping weight 1/2 lb. No. 1873, Adapter. **Your Price 65c**

MIDGET MICROPHONE



A real microphone of single button type. Extremely sensitive. Excellent for P.A. work, etc. Standard resistance of 100 ohms. Responds up to 2500 cycles. Ship. wt. 1 lb. No. 1655—Mike. **Your Price \$2.25**

MIDGET DYNAMIC SPEAKER



A real dynamic speaker with surprising volume and tone. 6 1/2" overall, 4 1/2" diaphragm. Standard 2500 ohm field coil. Output transformer to match all type output tubes. Wt. 5 lbs. No. 1549—Speaker. **Your Price \$2.50**

SPEED '295' TRIPLE-TWIN TUBE

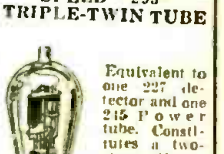

Equivalent to one 227 detector and one 215 power tube. Constitutes a two-stage direct-coupled amplifier in itself. Filament, 2 A.C. 2 1/2 v.; plate voltage 250. Large undistorted output. Ship. wt. 12 oz. No. S699, Tube. **Your Price \$1.85**

WE ARE A WHOLESALE HOUSE AND CANNOT ACCEPT ORDERS FOR LESS THAN \$3.00. If C. O. D. shipment is desired, please remit 20% remittance, which must accompany all orders. If full cash accompanies order, deduct 2% discount. Send money order—certified check—U. S. stamps.

Radio Trading Co.
23 West Broadway
New York, N. Y.

ORDER FROM THIS PAGE. You will find special prices from time to time in this magazine. Get our big FREE catalog for the greatest Radio Bargains. Should you wish goods shipped by parcel post, be sure to include sufficient extra remittance for same. Any excess will be refunded.

A SUPERSENSITIVE PHOTOELECTRIC CELL

By DR. FRITZ NOACK*

UNDER the name "Patin-Photocell" there is now being manufactured by the firm of Pressler in Leipzig a light-sensitive cell which is distinguished by extraordinary sensitivity. It is almost 100 times as responsive as the ordinary types of gas-filled photoelectric cells. Its circuit connections are shown in the figure.

This new device to all appearances does not differ in construction from previous types—it has the usual central anode, an alkali-coating anode on one-half the interior of the glass and is filled with alkali gas.

The Patin cell, like all other photoelectric cells, functions immediately before the setting in of the glow discharge; however, it here loses its similarity and exhibits its remarkable virtue of the spreading of field of its activity. Whereas earlier tube types have but a very limited band of action, the new cell may be acted upon with unusually high and changing quantities of light without there being any distortion of the amplitude of the resulting current. That is the "secret" of this new cell construction.

The "how" is equally interesting. By correct selection of the gasses and gas pressure and through correct selection of the distance between the anode and alkali-coated cathode, for a given light condition, this result may be obtained. Thus, for blue light, there would be selected for the coating perhaps calcium or sodium; and for yellow light, caesium or lithium, or a combination of both. The size of the alkali layer is about 15 sq. cm.; the internal resistance of the resulting cell averages about 0.5- to 1. megohm.

As usual for P. E. cells of this type the required potential in an amplifier circuit is about 190 volts; also, it should be resistance-capacity coupled to the amplified tube.

The value of R1 for "talkies" should be

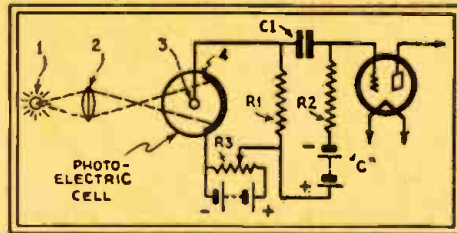

Connections of the supersensitive Patin P. E. cell.

about 0.5-megohm; for such services as television a higher value of resistance must be used.

In sound-on-film operation it has been possible to obtain an A. C. potential input to the amplifier tube of 0.5-volt; this figure is obtained with a plate potential of 190 volts and coupling resistor R1 of 0.5-megohm.

Referring to the illustration, the numerals carry the following descriptions: 1, light source; 2, condensing lens; 3, anode; 4, alkali cathode; R1, coupling resistor, 0.5-megohm, or more; R2, grid leak, 0.5- to 2 megohms; R3, a potentiometer of about 0.5-megohm in shunt to a 190 V. potential supply; battery "C" has a potential sufficient for correct operation of the control-grid circuit of the particular amplifier tube used; coupling condenser C1 may have a capacity between .005- and .015-mf.

For picture transmission a frequency of at least 25 kc. is required; in fact, for good pictures it is necessary to use frequencies up to 100 kc. At these extraordinarily high frequencies the Patin cell is not satisfactory as usually constructed; instead, it is necessary to use a special tube.

Due to the sharp line of demarcation between the points of operation of the ordinary types of P. E. cell it is of little use to connect a potentiometer for control of the

potential applied between its electrodes. The Patin cell, however, is readily controlled in this manner; in fact, it is probable that this method of control will find numerous industrial applications—particularly, in relay circuits. Potentiometer control also has some application in "talkies" systems using the Patin cell for pickup; the potentiometer may be located at a remote point. An arrangement such as this would not be possible if the earlier design of P. E. cell were used.

This broadening of the active range of a photoelectric cell is an improvement that is perhaps best likened to the "variable-mu" effect which has been introduced into some of the new vacuum tubes as a means of greatly increasing their undistorted output.

For sound-on-film reproduction it may be necessary to use a 3-stage resistance-capacity coupled amplifier. Under the same requirements of pickup and power output an installation incorporating the Patin cell would be able, due to its increased efficiency through the use of this cell, to achieve the same results with an amplifier system having a much lower degree of amplification. In this manner a saving may be effected in the initial cost of the equipment and in its subsequent service requirements.

This control-type P. E. cell is not as available on the American market. In fact, it is so new that its commercial aspects have hardly received consideration. Nevertheless, as its advantages become more obvious it will receive increasing attention. For instance, devices of this nature always receive a welcome in school and commercial laboratories as a demonstration and test instrument. Perhaps an American manufacturer may shortly make arrangements for the production of this tube.

At the moment it has received the serious consideration of the firm of C. Lorenz, A. G., as a component of their police flash image apparatus.

Experts in Germany have had nothing but words of praise for the Patin cell; they consider it to be a great step forward in the design of photoelectric equipment. I, myself, have witnessed a sound-film program of a sound installation incorporating in the pickup system one of these new tubes and I had the impression that the resulting sound was not only just as good but actually superior to the reproduction obtainable from the earlier type of P. E. cell. Continued development will undoubtedly increase this superiority.

* Berlin Correspondent.

== POST CARD == PLACE STAMP HERE

H. C. LEWIS, President
 COYNE ELECTRICAL SCHOOL, Dept. 62-8H
 500 S. Paulina Street
 CHICAGO, ILL

== POST CARD == PLACE STAMP HERE

LINCOLN RADIO CORPORATION
 Dept. RC-9
 329 So. Wood Street
 CHICAGO, ILL

== POST CARD == PLACE STAMP HERE

CABLE RADIO TUBE CORP.
 230-242 North 9th Street
 BROOKLYN, NEW YORK

== POST CARD == PLACE STAMP HERE

J. E. SMITH, President
 NATIONAL RADIO INSTITUTE
 Dept. 2JX
 WASHINGTON, D. C.

DRAFTING MUSICAL COMPOSITIONS

By OTTO KAPPELMAYER*

IN the January, 1932 issue of RADIO-CRAFT appeared an interesting article entitled, "The Radio Organ of a Trillion Tones." In this story Mr. Arnold Lesti disclosed the manner in which a draftsman could ink onto white Bristol-board a series of marks which could be resolved into any desired note or notes of the musical scale and with any desired timbre. Light-sensitive cells are essential components in the application of this method of musical composition.

Another method, still taking advantage of the light-sensitive cell, has recently been developed by the Russian, A. E. Scholpo, at the laboratory of the musical department of the National Historical Institute of Art in Leningrad. To his works he gives the name "designed composition." In short, the procedure is to draw on a paper ribbon an India-ink mark having varying area; by illuminating this ribbon and running it underneath a P. E. cell connected to an amplifier and reproducer system the designed frequencies may be reproduced as sound. The set-up is illustrated in the lower portion of the figure.

Hindemith, many years ago tried with success to do away with the laborious marking down of musical thoughts by the usual means of note writing and substituted the procedure of writing compositions for mechanical pianos direct on the music rolls.

Sound-on-film presents a much more flexible medium for the music author. In fact, the Englishman Humphries and sound technicians in America have attempted to chart human speech; however, the complexity of the human voice makes this an exceedingly difficult process.

Sound-film music may appear on the picture strip as a sequence of even, black, wavy mountains and valleys having much the appearance of a mountain profile as de-

* Berlin, Germany.

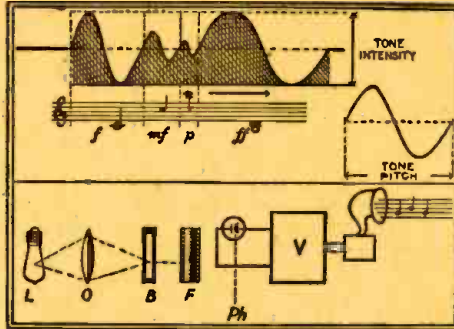

Above, "designed" notes; below, sound equipment.

picted in maps. The height of the wave controls the volume of the sound; the length controls its note; inasmuch as this film has a universal speed this factor may be neglected. Thus, a deep bass note is represented by a long wave and a high soprano by a short one, as represented in the upper portion of the illustration. (By "wave" is meant the distance between two points of equal wave height; a high note, for example, would look like twin needle points.)

With the two elements, wavelength and wave-height (amplitude), therefore, are connected the impressions of notes and their intensity, as far as the hearing is concerned.

Supposing a note is sounded over a period of several beats, perhaps as counterpoint, then simple wave pictures of this note must follow each other at regular intervals for the duration of the note. But if, as in a chord, several notes are sounded simultaneously, the curves or lines for the individual notes pile one above the other to produce a complex wave-form. The result is a tone.

"Designed compositions" are a natural result of this knowledge. The charted composition is written on millimeter paper and magnified

about ten times. Then, the composition is photographed onto sound film and, if desired, multiplied in the usual way.

Perhaps the most interesting element of this process is the masterful control which the composer has over his medium of expression. No longer is he limited by instrumental peculiarities or limitations such as the range of the notes or their tone; the volume, or the physical limitations of the musician.

He may (a), apply gliding tones, thereby subdividing into any number of fine divisions the previously twelve half-tones into which the octave is arranged; (b), introduce cutting staccatos and pearly glissandos, and; (c), produce entirely new tone colors and shades such as have never before been produced by any musical instrument anywhere in the world.

Therefore, the extension of the range of notes and tones and their volume; and the perfect flexibility of the modulation in this broadened world of sound open up many new possibilities for musical invention.

Transformation of the charted, wave sound-writing into audible sounds takes place by arranging the equipment in such a way that a source of light shines through a slit and onto the moving film strip. As the reflected light varies in intensity it affects in varying degree the conductivity of a photoelectric cell placed nearby. This cell is connected to an amplifier in the usual way; the output of this amplifier may be connected to a reproducer of any type.

By using reproducers of various types; and by introducing into the amplifier circuit filter characteristics of any desired kind, the original "designed music" may be still further modulated—much as an artisan puts a final finish onto a jewel.

The designed composition will not have its starting point from the world of music; instead, it will need to look for entirely new paths of sound expression in the world of human emotion and feeling.

Thus, at first, this new medium, like any other, will produce in us strange sensations quite different from anything we have previously known, but, in later years, when the creators of music will have established rapport with the new means of producing sound, they will have become free from the limitations of the present forms of sound expression. The final step in our appreciation of this new art will be achieved when our senses revel in stage presentations of "designed" music.

LINCOLN RADIO CORPORATION,
Dept. RC-9, 329 So. Wood Street,
Chicago, Ill.

Please send literature on () A. C. () D. C.

Name

Address

City State

(Print name and address plainly)

H. C. LEWIS, President
Radio Division, Coyne Electrical School
500 S. Paulina St., Dept. 62-8H, Chicago, Ill.

Dear Mr. Lewis:—Send me your Big Free Radio Book, and all details of your Special Offer.

Name

Address

City State

J. E. SMITH, President
National Radio Institute
Washington, D. C.

Dept. 2JX

Dear Mr. Smith: I want to take advantage of your Special Offer. Send me your two books, "Trouble Shooting in D.C., A.C. and Battery Sets" and "Rich Rewards in Radio." I understand this request does not obligate me.

Name

Address

City State "M"

CABLE RADIO TUBE CORP.
230-242 North 9th Street
Brooklyn, N. Y.

Gentlemen: Please send me current bulletins without charge or obligation on the items checked:

- SPEED Radio Tubes
- SPEED Television Tubes
- SPEED Foto-Lectric Tubes
- SPEED Triple-Twin Group

Name

Address

City State

"HONOR



BUILT"

PRICE

Some tubes are sold on low-price alone. Where price is the whole consideration, we can't possibly hope to sell Certified TRIADS, the Double-Checked Tubes, with an engineering pedigree accompanying each tube. The TRIAD certification slip assures the purchaser of positive satisfaction and the dealer of a real profit. In quantities, the discount is 50% to TRIAD Dealers and Servicemen.

QUALITY

Certified TRIAD Tubes are of superior and regular quality. They are all right up to a very high standard. The engineering slip which is sealed in with each tube assures you of absolute satisfaction with a real guarantee. Our story in a nutshell is "there are no better tubes that Certified TRIADS."



PREMIUMS

The announcement made in our "ad" last month practically cleaned out our stock of the \$18.00 Hammond Electric Clocks which we gave free to Certified TRIAD Dealers and Servicemen with their first 50.00 order—\$25.00 net. There are a few left.

We are now able to make another striking introductory offer. By an arrangement with the publishers we now offer a handsome copy of the popular *Official Radio Service Manual* or *Radio Encyclopedia* with each Dealer or Serviceman's initial order of 40.00—\$20.00 net. No radio organization is complete without copies of all these important books. Read the publishers' advertisements which tell you all about them, then send in your first order for



CERTIFIED

TRIAD

TUBES

The TRIAD Line is complete. It includes all types of standard Tubes as well as Photo-Electric Cells Television Tubes.

CERTIFIED TRIAD TUBES are licensed by RCA, and are sold at the same list prices.

TRIAD MANUFACTURING CO. Pawtucket, R. I.

My money order or check for \$20.00 is attached. In return, I want the CERTIFIED TRIAD TUBES listed from the regular TRIAD TUBE List amounting to \$40, less 50% discount. I am also to receive, ABSOLUTELY FREE, the manual checked below:

- 1931 OFFICIAL RADIO SERVICE MANUAL.
- 1932 OFFICIAL RADIO SERVICE MANUAL.
- 1933 OFFICIAL RADIO SERVICE MANUAL.
- S. GERNSBACK'S RADIO ENCYCLOPEDIA.

Name

Address

City..... State.....

My letterhead or business card is attached

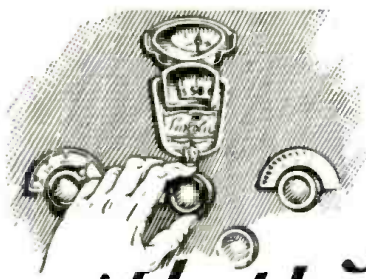

Tune the NEW way for World-Wide Reception with the LINCOLN DE·LUXE·SW·33

SILENT TUNING...

The weakest carrier wave is registered on the signal indicator and can be tuned with precision and perfect silence without disturbing atmospheric noises.

SIGNAL INDICATOR

A meter directly above the dial indicates, not only the weakest signal, but allows the operator to tune into a signal perfectly. Guess work is entirely eliminated. Comparative signal strength is indicated.

UNDISTORTED HIGH AMPLIFICATION

Three stages of push pull with new system of twin-grid detection allows tremendous undistorted amplification of the high gain I. F. amplifier. The handling power of this system seems to be unlimited and tremendous volume on weak signals can be had if desired.

AUTOMATIC VOLUME CONTROL.....

There are two paramount advantages in good automatic volume level. First, in tuning from weak to strong signals; and secondly, in holding a steady volume level on fading stations which is so common in short wave reception. The effect of this new Lincoln feature is so efficient that a near-by stroke of lightning registers only a muffled sound in the speaker; it has the same effect on all sharp electrical interference.

NEW FIDELITY

Twin-grid detection preceded by push pull input I. F. transformers and followed by two stages of transformer coupled push pull stages, produces an undistorted register of a wide band of frequencies, giving a perfectly balanced output with realism hard to associate with radio.

All of the new reactions in the SW-33 model are what we all have wanted for years,—they are here for you today—thanks to Lincoln's foresight in radio possibilities.

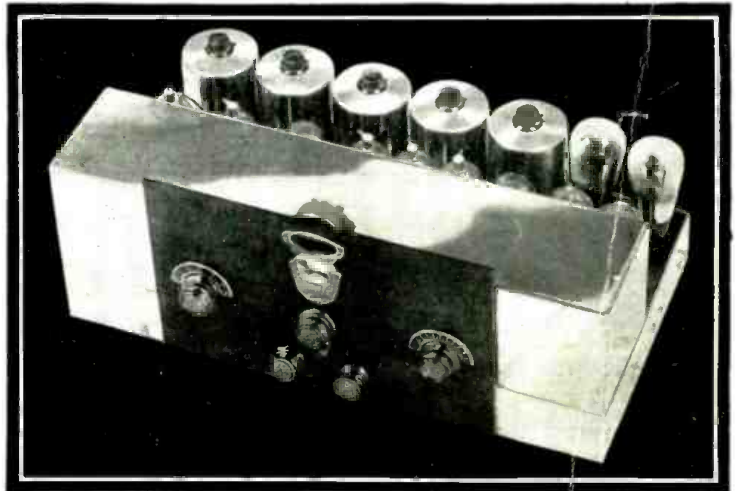

THE NEW DEVELOPMENTS

have made the new DeLuxe SW-33 just about as ideal a receiver as one could hope to own. The use of five variable mu tubes controlled by the new twin grid second detector and followed by two transformer coupled push pull stages has opened the gates to new ideas of enjoyable distant reception.

The signal indicator locates carrier waves which are difficult to hear; many times the carrier is not being used or modulated as is the case in transatlantic phone. The signal indicator registers these silent carriers and enables you to be accurately tuned, ready for the voice to be heard.

WHEN THIS CARRIER IS TUNED, ATMOSPHERIC NOISES ARE REDUCED TO A MINIMUM, AUTOMATICALLY.

Distant stations can be tuned silently, and volume then brought up to desired strength (volume control does not affect sensitivity). Perfect volume level on short wave stations is another great asset in the new Lincoln. If you have ever tuned in a foreign short wave station, or even many of our short wave stations in the U.S.A., you will appreciate the great value of uniform volume level.

The performance of Lincoln equipment has been known the world over for years. Its use by Polar Expeditions, broadcasting stations, both domestic and abroad, U. S. Naval Station operators, and hundreds of super critical DX fans, has proved Lincoln's exceptional merit.

Complete equipment consists of chassis, power equipment, auditorium type speaker and complete set of laboratory tested tubes. Chassis is finished in highly polished nickel over copper and presents a handsome appearance. Precision laboratory construction is employed throughout, and every receiver is tested on distance before shipment.

Write for description of new developments and new sales plan which overcome the present defects in the present custom built radio merchandising.

LINCOLN
DeLuxe Receivers

LINCOLN RADIO CORPORATION

Dept. RC-9, 329 S. Wood St., Chicago, Ill.

Please send information on A.C. D.C. receivers.

Name

Address

City State

Print name and address plainly